

ECONOMIC COMMISSION FOR EUROPE

INLAND TRANSPORT COMMITTEE

Working Party on Inland Water Transport

CEVNI

European code for inland waterways

Revision 2*

* Including the amendments introduced by resolutions Nos. 26, 27, 37, 39 and 43-47 of the Working Party on Inland Water Transport.



UNITED NATIONS
New York and Geneva, 2002

CEVNI - European Code for Inland Waterways

RESOLUTION No. 24

(Adopted on 15 November 1985, by the Working Party on Inland Water Transport)

The Working Party on Inland Water Transport,

Having regard to resolution No. 4 of the Sub-Committee on Inland Water Transport (TRANS/270, annex 1) concerning the application of the European Inland Waterway Navigation Code (CEVNI), and to the amended text of CEVNI reproduced in document W/TRANS/SC.3/37/Rev.2, which takes into account the Sub-Committee's resolutions Nos. 7 and 8 and its report TRANS/333, annex 1,

Noting that amendments concerning navigation on lakes and concerning navigation on rivers, in particular for small craft, have been added to CEVNI by resolutions Nos. 19 and 20 respectively (TRANS/SC.3/91, annex 1 and TRANS/SC.3/95),

Noting that, through the application of the recommendations of these resolutions by Governments and river commissions, the corresponding regulations in force on European inland waterways have to a large extent been harmonized,

Noting the increase in traffic on inland waterways and, *inter alia*, the development of sea-river transport and of modern techniques in navigation,

Noting the desirability, in the interest of safety in navigation, of taking into account in CEVNI developments in inland navigation and their consequences for the regulations in force,

Noting further the desirability of incorporating the special provisions concerning navigation on lakes and the rules of the road for small craft in the relevant parts of CEVNI,

Having considered the request by the Inland Transport Committee that CEVNI should be revised (W/TRANS/SC.3/37/Rev.2) (ECE/TRANS/23, para. 115),

Decides to replace the text of CEVNI, as reproduced in document W/TRANS/SC.3/37/Rev.2, and the amendments thereto reproduced in documents TRANS/SC.3/91, annex 1 and TRANS/SC.3/95, by the annex to this resolution, entitled "CEVNI: European Code for Inland Waterways", which is reproduced in document TRANS/SC.3/115,

Decides to formulate annexes 9, 10 and 11 after the revision of the European Provisions concerning the International Carriage of Dangerous Goods by Inland Waterway (ADN) (resolution No. 223 of the Inland Transport Committee),

Reiterates its recommendation addressed in resolution No. 4 to Governments and River Commissions to undertake, on the basis of the recommendations in paragraphs 1 and 2 below, the revision of regulations in force on inland waterways,

1. National regulations should consist of two parts:

(a) The first part should embody the provisions contained in the annex to this resolution under the title "CEVNI: European Code for Inland Waterways".

In reproducing these provisions, it is most desirable to maintain the existing order and numbering of the chapters and, so far as possible, the existing order, titles and wording of the articles themselves, but

(i) In cases where CEVNI provides for several possibilities, not all of those possibilities need be included in the national regulations;

(ii) Governments may omit certain provisions of CEVNI, or may enact additional or different provisions in cases where footnotes give them discretion to do so or where such additional or different provisions are necessitated by changes in the conditions of navigation (in the latter case, they should inform the secretariat of the changes they have made);

(b) The second part should contain the specific provisions which Governments consider necessary in view of local conditions. These specific provisions should not be at variance with the provisions of CEVNI, including any which may not have been reproduced in the first part. Further, with regard to matters to which the provisions of CEVNI apply, and particularly, to the marking of vessels, Governments should not, in the absence of very special local conditions, impose any obligations which are not contained in CEVNI itself;

2. In every country, the first part of the regulations should, if possible, be the same for all the inland waterways of the country concerned; nevertheless, a Government may depart from this rule if the special characteristics of the various inland waterway networks in the country concerned are so different that it cannot be applied;

Requests Governments and River Commissions to inform the Executive Secretary of the Economic Commission for Europe by 1 July 1987 whether they can implement this resolution,

Requests the Executive Secretary of the Economic Commission for Europe to place the question of the application of this resolution periodically on the agenda of the Working Party on Inland Water Transport.

TABLE OF CONTENTS

	<u>Page</u>
CHAPTER 1 - GENERAL PROVISIONS	9
Article 1.01 - Meaning of certain terms	9
Article 1.02 - Boatmaster	12
Article 1.03 - Duties of crew and other persons on board	13
Article 1.04 - General obligation to exercise vigilance	13
Article 1.05 - Conduct in special circumstances	14
Article 1.06 - Use of the waterway.....	14
Article 1.07 - Maximum load and maximum number of passengers	14
Article 1.08 - Construction, rigging and crews of vessels	14
Article 1.09 - Steering	15
Article 1.10 - Ship's papers	15
Article 1.11 - Navigation regulations	16
Article 1.12 - Dangerous objects on board; loss of objects; obstacles ...	16
Article 1.13 - Protection of waterway signs and marking	17
Article 1.14 - Damage to permanent structures	17
Article 1.15 - Prohibition of discharge into waterways	17
Article 1.16 - Salvage and assistance	17
Article 1.17 - Grounded or sunken vessels	18
Article 1.18 - Obligation to clear the channel	18
Article 1.19 - Special instructions	18
Article 1.20 - Inspection	18
Article 1.21 - Special transport operations	18
Article 1.22 - Special temporary requirements	19
Article 1.23 - Authorization of public events	19
CHAPTER 2 - MARKS AND DRAUGHT SCALES ON VESSELS; TONNAGE MEASUREMENT	20
Article 2.01 - Identification marks on vessels other than small craft	20
Article 2.02 - Identification marks on small craft	21
Article 2.03 - Tonnage measurement	21
Article 2.04 - Draught marks and draught scales	21
Article 2.05 - Identification marks on anchors	22
CHAPTER 3 - VISUAL SIGNALS (MARKING) ON VESSELS	23
I. GENERAL	23
Article 3.01 - Application and definitions	23
Article 3.02 - Lights	23
Article 3.03 - Boards, flags and pennants	24

TABLE OF CONTENTS (*continued*)

	<u>Page</u>
Article 3.04 - Cylinders, balls, cones and bicones	24
Article 3.05 - Prohibited lights and signals	24
Article 3.06 - Emergency lights	25
Article 3.07 - Prohibited use of lamps, searchlights, boards, flags, etc.	25
II. NIGHT AND DAY MARKING	25
II.A. MARKING WHEN UNDER WAY	25
Article 3.08 - Marking for motorized vessels proceeding alone	25
Article 3.09 - Marking for towed convoys under way	26
Article 3.10 - Marking for pushed convoys under way	28
Article 3.11 - Marking for side-by-side formations under way	29
Article 3.12 - Marking for sailing vessels under way	30
Article 3.13 - Marking for small craft under way	31
Article 3.14 - Additional marking for vessels carrying out certain transport operations involving dangerous substances	32
Article 3.15 - Marking of vessels authorized to carry more than 12 passengers with a hull length of not more than 20 m	34
Article 3.16 - Marking for ferry-boats under way	34
Article 3.17 - Additional marking for vessels enjoying priority of passage	35
Article 3.18 - Additional marking for vessels unable to manoeuvre	36
Article 3.19 - Marking for assemblies of floating material and floating establishments under way	36
II.B. MARKING WHEN STATIONARY	36
Article 3.20 - Marking for stationary vessels	36
Article 3.21 - Additional marking for stationary vessels carrying out certain transport operations involving dangerous substances	38
Article 3.22 - Marking for ferry-boats made fast at their landing-stage	38
Article 3.23 - Marking for assemblies of floating material and floating establishments when stationary	38
Article 3.24 - Marking for nets or poles of stationary vessels	38
Article 3.25 - Marking for floating equipment at work and for grounded or sunken vessels	39
Article 3.26 - Marking for anchors that may be a danger to navigation	40

TABLE OF CONTENTS (*continued*)

	<u>Page</u>
III. SPECIAL MARKING	41
Article 3.27 - Additional marking for vessels of the supervising authorities and fire-fighting services	41
Article 3.28 - Additional marking for vessels under way carrying out work in the waterway	41
Article 3.29 - Additional marking for protection against wash	42
Article 3.30 - Distress signals	42
Article 3.31 - Prohibition of boarding	43
Article 3.32 - Prohibition of smoking	43
Article 3.33 - Prohibition of lateral berthing	43
Article 3.34 - Additional marking for vessels whose ability to manoeuvre is limited	44
Article 3.35 - Additional marking for vessels engaged in fishing	45
Article 3.36 - Additional marking for vessels used for underwater diving	46
Article 3.37 - Additional marking for vessels engaged in minesweeping	46
Article 3.38 - Additional marking for vessels on pilotage service	46
CHAPTER 4 - SOUND SIGNALS ON VESSELS - RADIOTELEPHONY	47
Article 4.01 - General	47
Article 4.02 - Use of sound signals	48
Article 4.03 - Prohibited sound signals	48
Article 4.04 - Radiotelephony	48
CHAPTER 5 - WATERWAY SIGNS AND MARKING	50
Article 5.01 - Signs	50
Article 5.02 - Marking	50
CHAPTER 6 - RULES OF THE ROAD	51
A. GENERAL	51
Article 6.01 - Definitions	51
Article 6.01 <i>bis</i> - High-speed vessels	52
Article 6.02 - Small craft: General rule	52
B. MEETING, CROSSING AND OVERTAKING	52
Article 6.03 - General principles	52
Article 6.03 <i>bis</i> - Crossing	53

TABLE OF CONTENTS (*continued*)

	<u>Page</u>
Article 6.04 - Meeting: Normal rules	54
Article 6.05 - Meeting: Departures from normal rules	55
Article 6.06 - Meeting boats towed from the bank	57
Article 6.07 - Meeting in narrow channels	57
Article 6.08 - Meeting prohibited by waterway signs	58
Article 6.09 - Overtaking: General provisions	59
Article 6.10 - Overtaking	59
Article 6.11 - Overtaking prohibited by waterway signs	60
C. OTHER RULES OF THE ROAD	60
Article 6.12 - Navigation on sections where the course is prescribed	60
Article 6.13 - Turning	61
Article 6.14 - Procedure on departure	61
Article 6.15 - Prohibition of entering the spaces between vessels in a towed convoy	61
Article 6.16 - Harbours and tributary waterways: entering and leaving; leaving followed by crossing the waterway	62
Article 6.17 - Sailing abreast	63
Article 6.18 - Prohibition of trailing of anchors, cables or chains	63
Article 6.19 - Drifting	64
Article 6.20 - Wash	64
Article 6.21 - Convoys	64
Article 6.21 <i>bis</i> - Relocation of pushed barges outside a pushed convoy	65
Article 6.22 - Suspension of navigation	65
Article 6.22 <i>bis</i> - Navigation when passing floating equipment at work or grounded or sunken vessels, and vessels whose ability to manoeuvre is limited	65
D. FERRY-BOATS	65
Article 6.23 - Rules applicable to ferry-boats	65
E. PASSAGE UNDER BRIDGES AND THROUGH WEIRS AND LOCKS	66
Article 6.24 - Passage under bridges and through weirs: General	66
Article 6.25 - Passage under fixed bridges	66
Article 6.26 - Passage under movable bridges	67
Article 6.27 - Passage through weirs	68
Article 6.28 - Passage through locks	68
Article 6.28 <i>bis</i> - Entering and leaving locks	69
Article 6.29 - Priority of passage through locks	70

TABLE OF CONTENTS (*continued*)

	<u>Page</u>
F. REDUCED VISIBILITY - NAVIGATION BY RADAR	71
Article 6.30 - General rules for navigation in reduced visibility	71
Article 6.31 - Sound signals when stationary	72
Article 6.32 - Provisions for vessels navigating by radar	73
Article 6.33 - Provisions for vessels not navigating by radar	75
G. SPECIAL RULES	76
Article 6.34 - Special priorities	76
Article 6.35 - Water skiing and similar activities	76
Article 6.36 - Conduct of, and in respect of, fishing vessels	77
Article 6.37 - Conduct of, and in respect of, underwater divers for sport	77
CHAPTER 7 - BERTHING RULES	78
Article 7.01 - General principles of berthing	78
Article 7.02 - Berthing	78
Article 7.03 - Anchoring	79
Article 7.04 - Making fast	79
Article 7.05 - Berthing areas	79
Article 7.06 - Berthing authorized for certain types of vessel	80
Article 7.07 - Berthing in the vicinity of vessels, pushed convoys and side-by-side formations carrying out certain transport operations involving dangerous substances	80
Article 7.08 - Watch and surveillance	81
CHAPTER 8 - COMPLEMENTARY PROVISIONS	82
Article 8.01 - Reporting requirements	82
CHAPTER 9 - PREVENTION OF POLLUTION OF WATER AND DISPOSAL OF WASTE OCCURRING ON BOARD VESSELS	83
Article 9.01 - Definitions	83
Article 9.02 - General obligation to exercise vigilance	85
Article 9.03 - Prohibition on discharging and dumping	85
Article 9.04 - On-board collection and processing of waste	86
Article 9.05 - Pollution prevention register (used-oil log), requirements for delivery to reception facilities	86
Article 9.06 - Painting and external cleaning of vessels	87

TABLE OF CONTENTS (*continued*)

ANNEXES

	<u>Page</u>
1. Distinguishing letter or group of letters indicating country of vessel's home port or place of registration	89
2. Draught scales on inland waterway vessels	91
3. Visual signals (marking) on vessels	93
4. Lights and the colour of signal lights on vessels	117
5. Intensity and range of signal lights on vessels	121
6. Sound signals	125
7. Waterway signs and marking	133
8. Buoyage and marking of waterways, lakes and broad waterways	153
9. Model used-oil log	173

SUPPLEMENT

Specific requirements in the national regulations of Belarus, Kazakhstan, the Republic of Moldova, the Russian Federation and Ukraine that differ at present from the provisions of CEVNI	177
---	-----

Chapter 1

GENERAL PROVISIONS

Article 1.01 - Meaning of certain terms

In these regulations:

(a) The term “vessel” means any inland waterway craft, including small craft and ferry-boats, as well as floating equipment and seagoing vessels;¹

(b) The term “motorized vessel” means any craft using its own mechanical means of propulsion, except craft whose engines are used only to cover short distances (in harbours or at loading and unloading points) or to make them easier to handle while being towed or pushed;

(c) The term “sailing vessel” means any vessel proceeding under sail only; a vessel proceeding under sail and making use at the same time of its own mechanical means of propulsion shall be considered as a motorized vessel;

(d) The term “small craft” means any vessel with a hull less than 20 m long,² except vessels built or equipped to tow, push or propel in side-by-side formation vessels other than small craft, craft authorized to carry more than 12 passengers and ferry-boats;

(e) The term “floating equipment” means floating structures carrying machinery used for work on waterways or in harbours (dredgers, elevators, derricks, cranes, etc.);

(f) The term “floating establishment” means any floating installation that is normally a fixture, e.g. swimming baths, docks, wharves or boat-sheds;

(g) The term “assembly of floating material” means a raft or any construction, assembly or object capable of navigation, other than a vessel or floating establishment;

(h) The term “ferry-boat” means any vessel providing a transport service across a waterway, that is classed as a ferry-boat by the competent authorities;³

¹ The competent authorities may, on certain waterways much used by seagoing ships, exempt such vessels from compliance with some of the provisions of these regulations.

² The competent authorities may in the application of the provisions of CEVNI and for particular waterways limit the category of small craft to vessels of 15 m long.

³ The competent authorities shall in any case class as “ferry-boats” all vessels providing such a service which do not move independently.

- (i) The term “pushed barge” means any vessel designed or specially equipped to be pushed;
- (j) The term “shipborne barge” means a pushed barge designed to be carried on board seagoing vessels and to navigate on inland waterways;
- (k) The term “convoy” means a towed convoy, a pushed convoy or a side-by-side formation;
- (l) The term “towed convoy” means any group consisting of one or more vessels, floating establishments or assemblies of floating material towed by one or more motorized vessels, the later forming part of the convoy and being known as tugs;
- (m) The term “pushed convoy” means a rigid¹ group of vessels, one at least of which is placed in front of the motorized vessel propelling the convoy and is known as a pusher;
- (n) The term “side-by-side formation” means a group consisting of vessels coupled side by side, none of which is placed in front of the motorized vessel propelling the formation;
- (o) A vessel, an assembly of floating material or a floating establishment is “stationary” when it is, directly or indirectly, anchored or made fast to the shore;
- (p) A vessel, an assembly of floating material or a floating establishment is “under way” or “proceeding” when it is neither directly nor indirectly at anchor, made fast to the shore or grounded. For such vessels, floating equipment or floating establishments under way, the term “stop” applies with respect to the land;
- (q) The term “vessel engaged in fishing” means any vessel fishing with nets, lines, trawls or other fishing apparatus that restrict manoeuvrability, but does not apply to a vessel fishing with trolling lines or other fishing apparatus that does not restrict manoeuvrability;
- (r) The terms “white light”, “red light”, “green light”, “yellow light” and “blue light” mean lights of colours conforming to the provisions of annex 4 to these regulations;

¹ The competent authorities may class some non-rigid groups as “pushed convoys”.

(s) The terms “strong light”, “bright light” and “ordinary light” mean lights of intensities conforming to the provisions of annex 5 to these regulations;

(t) The term “scintillating light” means a rhythmic light flashing 50-60 times per minute;

(u) The term “short blast” means a blast lasting approximately one second, and the term “long blast” means a blast lasting approximately four seconds, the interval between two consecutive blasts being about one second;

(v) The term “series of very short blasts” means a series of at least six blasts lasting approximately $\frac{1}{4}$ second each, separated by intervals of approximately $\frac{1}{4}$ second;

(w) The term “three-tone signal” means a signal repeated three times, of three blasts of different pitch with no interval between them lasting about two seconds in all. The frequency of the blasts shall be within the range 165 to 297 Hertz and the difference between the highest and the lowest blasts shall be at least two full notes. Each series of three blasts shall begin with the lowest and end with the highest note;

(x) The term “night” means the period between sunset and sunrise;

(y) The term “day” means the period between sunrise and sunset;

(z) The term “state of fatigue” means a state occurring as the result of insufficient rest or of sickness, and expressed in deviations from the norm in behaviour and reaction speed;

(aa) The term “state of intoxication” means a state occurring as a result of the use of alcohol, narcotics, medicines or other similar substances and determined from the results of laboratory examination or from clinical symptoms in accordance with national legislation and practice;

(bb) The term “water bike” means any small craft using its own mechanical means of propulsion, which is able to carry one or more persons and built or designed to be used for skiing over the water or performing figures, for example, waterbobs, waterscooters, jetbikes, jetski and other similar craft.¹

¹ The competent authority may define a water bike as an assembly of floating material instead of a small craft.

Article 1.02 - Boatmaster¹

1. Every vessel or assembly of floating material, except vessels in a pushed convoy other than the pusher, shall be placed under the authority of a person having the necessary qualifications.^{2 3} This person is hereinafter referred to as the boatmaster.
2. Every convoy shall likewise be placed under the authority of a person having the necessary qualifications.³ This boatmaster shall be appointed as follows:
 - (a) In the case of a convoy with only one motorized vessel, the boatmaster of the convoy shall be the boatmaster of the motorized vessel;
 - (b) In the case of a towed convoy led by two or more motorized vessels in line, the boatmaster of the convoy shall be the boatmaster of the leading vessel, unless that vessel is a temporary auxiliary tug, in which case the boatmaster of the convoy shall be the boatmaster of the second vessel;
 - (c) In the case of a towed convoy led by two or more motorized vessels not in line, one of which provides the main traction, the boatmaster of the convoy shall be the boatmaster of the vessel providing the main traction;
 - (d) In a pushed convoy propelled by two pushers side by side, the boatmaster of the starboard pusher shall be the boatmaster of the convoy;⁴
 - (e) In other cases, the boatmaster of the convoy shall be appointed when required.
3. When a vessel is under way the boatmaster shall be on board; in addition, the boatmaster of floating equipment shall always be on board when the equipment is in operation.

¹ The competent authorities may use the term “chef de bord” instead of the term “conducteur” currently used in the French text of CEVNI as long as it means a person exercising a nautical responsibility on board a vessel. The question of the use of one or the other term in the French text of CEVNI is under consideration by the Working Party.

² The competent authorities may waive this provision in the case of certain assemblies of floating material and non-motorized vessels in certain side-by-side formations.

³ The competent authorities may lay down requirements regarding these qualifications.

⁴ The competent authorities may prescribe that the boatmaster of a pusher of a higher propelling power shall be the boatmaster of the convoy.

4. The boatmaster is responsible for compliance with these regulations on his vessel, convoy or assembly of floating material. In a towed convoy, the boatmasters of the towed vessels shall obey the orders of the boatmaster of the convoy; however, even without such orders, they shall take all steps required by the circumstances for the proper handling of their vessels. The same provisions apply to boatmasters of vessels in a side-by-side formation who are not the boatmaster of the formation.¹

5. Every floating establishment shall be placed under the authority of a person. This person shall be responsible for the observance of the provisions of these regulations on the floating establishment.

6. The faculties of the boatmaster shall not be impaired as a result of a state of fatigue or intoxication.

Article 1.03 - Duties of crew and other persons on board

1. Crew members shall carry out the orders given them by the boatmaster in the performance of his duties. They shall assist in complying with the requirements of these regulations and of any other provisions applicable.

2. All other persons on board are required to comply with the orders given them by the boatmaster in the interest of safe navigation or of good order on board.

3. Members of the crew and other persons on board who temporarily determine the vessel's course and speed themselves shall also be responsible in that respect for ensuring compliance with the requirements of these regulations.

4. The faculties of crew members on duty and other persons on board who participate temporarily in the navigation of the vessel shall not be impaired as a result of a state of fatigue or intoxication.

Article 1.04 - General obligation to exercise vigilance

1. Even where no special rules are laid down in these regulations, boatmasters shall take all the precautions required by the general obligation to exercise vigilance and good navigational practice in order to avoid, in particular:

- (a) Danger to human life;
- (b) Damage to vessels or assemblies of floating material, banks, works or installations of any kind on or adjacent to the waterway;
- (c) Causing obstructions to shipping; and
- (d) As far as possible, causing damage to the environment.

¹ When circumstances make it necessary for two or more vessels and/or convoys to sail together (for example with the support of an ice-breaker), the relationships between the boatmasters are determined by the competent authority.

2. The above provisions shall also apply to persons in charge of floating establishments.

Article 1.05 - Conduct in special circumstances

To avoid imminent danger, boatmasters shall take all the steps required by the situation, even if this entails departing from these regulations.

Article 1.06 - Use of the waterway

The length, width, height, draught and speed of vessels, convoys and assemblies of floating material shall be suited to the characteristics of the waterway and its installations.¹

Article 1.07 - Maximum load and maximum number of passengers

1. Vessels shall not be loaded beyond their maximum draught markings.
2. The load shall not endanger the vessel's stability or the strength of the hull. The load shall not restrict the direct or indirect view at a distance of more than 350 m in front of the vessel or convoy under way.
3. Passenger vessels shall not have on board more passengers than the number authorized by the competent authorities.

Article 1.08 - Construction, rigging and crews of vessels

1. Vessels and assemblies of floating material shall be so constructed and rigged as to ensure the safety of those on board and safe navigation and to be able to satisfy the requirements of these regulations.
2. All vessels, except vessels in a pushed convoy other than the pusher, shall have a crew sufficient in number and sufficiently skilled to ensure the safety of those on board and safe navigation. However, non-motorized vessels in a side-by-side formation and some of the towed vessels in a rigid group are not required to have a crew when the crew of the other vessels in the side-by-side formation or rigid group is sufficiently large and skilled to ensure the safety of those on board and safe navigation.

¹ The competent authorities may lay down rules on this matter, taking traffic density into account if necessary.

Article 1.09 - Steering

1. When under way, a vessel shall be steered by at least one qualified person of not less than 16 years of age.¹
2. In order to ensure proper control of the vessel, the helmsman shall be able to receive and give all information and all orders reaching or proceeding from the wheelhouse. In particular, he shall be able to hear sound signals and have a sufficiently clear view in all directions. If a sufficiently clear view is not possible, he has to have a possibility to use an optical means giving a clear and undistorted image over an adequate field.
3. When particular circumstances so require, a look-out or listening-post shall be set up to keep the helmsman informed.

Article 1.10 - Ship's papers

1. Every vessel shall carry:
 - (a) A certificate of registry;
 - (b) A tonnage certificate (cargo vessels only);
 - (c) Ship's articles or crew list;
 - (d) A ship's log;²

and any other documents relating to navigation required under international conventions or agreements.

2. By derogation from paragraph 1 above, small craft are not required to carry the documents referred to in subparagraphs (b) and (d); moreover, in the case of small pleasure craft, the document referred to in subparagraph (c) is not required, and that referred to in subparagraph (a) may be replaced by a national navigation permit.
3. Assemblies of floating material shall carry a national navigation permit.³
4. The documents required to be carried on board under these regulations or any other provisions applicable shall be produced whenever requested by officials of the competent authorities.

¹ The competent authorities may prescribe other provisions concerning age.

² The competent authorities may waive the requirement to carry this document. If they do require it, they shall exempt from producing it vessels registered in countries where it is not required.

³ The competent authorities may waive this provision.

5. However, the certificate of registry and the tonnage certificate need not be carried on board a pushed barge to which is affixed a metal plate conforming to the following model:

Official No.:
Certificate of registry No.:
Competent authority:
Expiry date:

These particulars shall be engraved or stamped in easily legible characters not less than 6 mm high. The metal plate shall be not less than 60 mm high and 120 mm long; it shall be permanently affixed in a prominent place towards the stern of the barge on the starboard side.

The conformity of the particulars given on the plate to those in the barge's certificate of registry shall be certified by the competent authority, whose stamp shall be applied to the plate. The certificate of registry and tonnage certificate shall be kept by the owner of the barge.¹

Article 1.11 - Navigation regulations

An update copy of the navigation regulations applicable to the waterway shall be carried on board every vessel, except vessels in a pushed convoy other than the pusher, and on every assembly of floating material.²

Article 1.12 - Dangerous objects on board; loss of objects; obstacles

1. It is prohibited to allow objects that would constitute a danger to vessels, assemblies of floating material, floating establishments or installations on or adjacent to the waterway to project beyond the sides of vessels or of assemblies of floating material.
2. When anchors are weighed, they shall not hang below the bottom or keel of a vessel or the bottom of an assembly of floating material.
3. When a vessel, an assembly of floating material or a floating establishment loses an object and this may cause an obstruction or danger to navigation, the boatmaster or the person responsible for the floating establishment shall at once inform the nearest competent authorities, specifying as accurately as possible the place where the object was lost. If possible, he shall also place a marker at the spot.

¹ The competent authorities may allow photocopies of the certificate of registry and the tonnage certificate, certified as true copies by a competent authority, to be carried on board the pusher.

² The competent authorities may exempt certain classes of small craft and of assemblies of floating material from this regulation.

4. When a vessel encounters an unknown obstacle on a waterway, the boatmaster shall at once inform the nearest competent authority, specifying as accurately as possible the place where the obstacle was encountered.

Article 1.13 - Protection of waterway signs and marking

1. It is prohibited to use waterway signs or marking (boards, buoys, floats, beacons, etc.) for mooring or warping vessels or assemblies of floating material, to damage them or to render them unfit for use.

2. When a vessel or an assembly of floating material has displaced or damaged any device or installation which is part of the system of waterway signs and marking, the boatmaster shall at once inform the nearest competent authority.

3. Every boatmaster has a general duty immediately to inform the nearest competent authority of any incident or accident affecting waterway signs or marking (failure of a light, displacement of a buoy, destruction of a sign, etc.).

Article 1.14 - Damage to permanent structures

When a vessel or assembly of floating material has damaged a permanent structure (lock, bridge, etc.), the boatmaster shall at once inform the nearest competent authority.

Article 1.15 - Prohibition of discharge into waterways

1. It is forbidden to throw, pour or allow to fall or flow into a waterway any objects or substances likely to cause an obstruction or danger to navigation or to other users of the waterway.

2. It is in particular forbidden to throw, pour or discharge into a waterway any form of petroleum waste or mixtures of such waste with water.

3. In the event of accidental spillage of a substance covered by paragraph 1 or paragraph 2 or of any risk of such spillage, the boatmaster shall immediately inform the nearest competent authority, specifying as accurately as possible the nature and site of the spillage.

Article 1.16 - Salvage and assistance

1. In the event of an accident endangering those on board, the boatmaster shall use every means at his disposal to save them.

2. Every boatmaster who is close to a vessel or assembly of floating material which has suffered an accident endangering persons or threatening to obstruct the channel is required to give immediate assistance insofar as is consistent with the safety of his own vessel.

Article 1.17 - Grounded or sunken vessels

1. The boatmaster of a grounded or sunken vessel or of a grounded or broken assembly of floating material shall arrange for the nearest competent authority to be informed as soon as possible. In the case of a grounded or sunken vessel, the boatmaster or a member of the crew shall remain on board or near the site of the accident until the competent authority has authorized him to leave.
2. When a vessel is grounded or sunk, or an assembly of floating material is grounded, in or near the channel, its boatmaster shall, unless it is obviously unnecessary, as soon as possible and without prejudice to the obligation to display the marking referred to in article 3.25, give warning to approaching vessels and assemblies of floating material at suitable points far enough from the site of the accident to enable them to take the necessary action in good time.
3. Should an accident occur while a vessel is passing through a lock, the boatmaster shall immediately inform the service in charge of the lock in question.

Article 1.18 - Obligation to clear the channel

1. When a grounded or sunken vessel, a grounded assembly of floating material or an object lost by a vessel or assembly of floating material causes or threatens to cause total or partial obstruction of the channel, the boatmaster of the vessel or assembly of floating material shall endeavour to get the channel cleared as soon as possible.
2. A boatmaster whose vessel is in danger of sinking or becomes impossible to control is under the same obligation.

Article 1.19 - Special instructions

Boatmasters and persons in charge of floating establishments shall comply with any special instructions given them by officials of the competent authorities in order to ensure safe and orderly navigation.

Article 1.20 - Inspection

Boatmasters and persons in charge of floating establishments shall give officials of the competent authorities the necessary facilities for verifying compliance with these regulations and any other provisions applicable, and in particular facilitate immediate boarding by them.

Article 1.21 - Special transport operations

1. Movements on inland waterways are deemed to be special transport operations if they are movements of:
 - (a) Vessels or convoys which do not comply with the requirements of articles 1.06 and 1.08;

(b) Floating establishments or assemblies of floating material, unless it is evident that their movement cannot cause any hindrance or danger to navigation or any damage to permanent structures.

2. Such a transport operation shall be allowed only under a special authorization issued by the competent authorities of the sector or sectors over which it is to take place.
3. It shall be subject to such conditions as those authorities may determine in each case.
4. A boatmaster shall be appointed for each transport operation, account being taken of the provisions of article 1.02.

Article 1.22 - Special temporary requirements

Boatmasters shall comply with any temporary requirements issued by a competent authority in special circumstances and published as notices to ensure safe and orderly navigation.

Article 1.23 - Authorization of public events

Sporting events, regattas or other public events which may endanger safe and orderly navigation shall be subject to authorization by the competent authorities.

Chapter 2

MARKS AND DRAUGHT SCALES ON VESSELS; TONNAGE MEASUREMENT

Article 2.01 - Identification marks on vessels other than small craft

1. Every vessel, except small craft, shall bear the following identification marks on its hull or on fixed boards or plates:

- (a) Its name or emblem

The name shall be inscribed on both sides of the vessel; in the case of motorized vessels, it shall also be inscribed in a position visible from astern. If, in a side-by-side formation or pushed convoy, one or more of the inscriptions of the propelling vessel's name are hidden, the name shall be reproduced on boards so placed as to be clearly visible from the directions from which those inscriptions are hidden. If the vessel has no name or emblem, it shall bear either the name (or its usual abbreviation) of the organization to which it belongs followed, where applicable, by a number, or the registration number followed, in order to show the country of the vessel's home port or place of registry, by the letter or letters assigned to that country in annex 1 to these regulations.

- (b) Its home port or place of registry

The name of the home port or place of registry shall be inscribed either on both sides of the vessel or on its stern and shall be followed by the letter or letters indicating the country of that home port or place of registry.

2. In addition, except for small craft,

(a) Every cargo vessel shall have its dead-weight tonnage inscribed on both sides, on the hull or on fixed boards;

(b) Every passenger vessel shall display the maximum permissible number of passengers in a conspicuous position on board.

3. The above-mentioned identification marks shall be inscribed in easily legible and indelible Latin characters, their inscription in oil paint being considered indelible. The height of the characters shall be not less than 20 cm for the name and not less than 15 cm for other marks. The width of the characters and the thickness of strokes shall be in proportion to the height. The characters shall be of a light colour against a dark background or vice versa.

4. As an exception to the preceding paragraphs, seagoing vessels may maintain their identification marks.

Article 2.02 - Identification marks on small craft¹

1. Small craft shall bear the official registration marks; if those marks are not prescribed, they shall bear:
 - (a) Their name or emblem;
 - (b) The name and domicile of the owner.
2. The registration or identification marks mentioned under paragraph 1 (a) shall be inscribed on the outside of the craft in Latin characters not less than 10 cm high, easily legible and indelible, their inscription in oil paint being considered indelible. If the craft has no name or emblem, it shall bear the name (or its usual abbreviation) of the organization to which it belongs, followed, where applicable, by a number.
3. The name and domicile of the owner shall be displayed in a conspicuous position inside or outside the craft.
4. However, ship's boats need only bear, inside or outside, the name of the vessel to which they belong and any other particulars needed to identify the owner.

Article 2.03- Tonnage measurement

Every inland waterway cargo vessel, except small craft, shall have its tonnage capacity measured.

Article 2.04 - Draught marks and draught scales²

1. All vessels, except small craft, shall bear marks showing the maximum draught level. In the case of inland waterway vessels, the methods by which the maximum draught is determined and the conditions to be observed in affixing the draught marks shall be laid down in the rules concerning technical requirements which correspond to the Recommendations on Technical Requirements for Inland Navigation Vessels (annex to Resolution No. 17, revised) (TRANS/SC.3/104). In the case of seagoing vessels, the summer fresh-water line shall serve in place of draught marks.
2. Every vessel which may draw as much as 1 m of water shall be provided with draught scales. In the case of inland waterway vessels, annex 2 to these regulations lays down the conditions to be observed in affixing the draught scales.

¹ The competent authorities may prescribe other provisions for small craft which are neither motorized nor sailing craft and for sailboards or small sailing craft less than 7 m long.

² The competent authorities may waive the requirement for these marks and scales.

Article 2.05 - Identification marks on anchors

1. The anchors of vessels shall bear identification marks in indelible characters.

If an anchor is used on another vessel belonging to the same owner, the original marking may be kept.

2. The obligation contained in paragraph 1 shall not apply to the anchors of seagoing vessels or of small craft.

Chapter 3

VISUAL SIGNALS (MARKING) ON VESSELS

I. GENERAL

Article 3.01 - Application and definitions

1. Articles 3.08 to 3.19, 3.28, 3.34, 3.35, 3.37 and 3.38 shall apply to vessels under way and articles 3.20 to 3.26 to stationary vessels. Articles 3.21, 3.23 and 3.26 shall apply also to vessels, assemblies of floating material or floating establishments, when they are grounded.
2. When visibility conditions so require, the visual signals prescribed for use at night shall also be displayed by day.
3. For the application of this chapter, pushed convoys whose maximum dimensions do not exceed 110 m by 12 m are regarded as single motorized vessels.
4. Sketches of the signals prescribed in this chapter are contained in annex 3 to these regulations.
5. In this chapter:
 - (a) The term “masthead light” means a strong white light projecting an uninterrupted beam throughout a horizontal arc of 225° and placed so as to project that beam from the bow to 22°30' abaft the beam on each side;
 - (b) The term “side lights” means a bright green light to starboard and a bright red light to port, each of these lights projecting an uninterrupted beam throughout a horizontal arc of 112°30' and placed so as to project that beam from the bow to 22°30' abaft the beam on its side;
 - (c) The term “stern light” means an ordinary or bright white light projecting an uninterrupted beam throughout a horizontal arc of 135° and placed so as to project this beam throughout an arc of 67°30' along each side from the stern;
 - (d) The term “light visible from all directions” means a light projecting an uninterrupted beam throughout a horizontal arc of 360°;
 - (e) The term “height” means the height above the level of the draught marks or, for vessels without draught marks, above the hull.

Article 3.02 - Lights

Unless otherwise provided, the lights prescribed in these regulations shall show a continuous and uniform beam.

Article 3.03 - Boards, flags and pennants

1. Unless otherwise provided, the boards and flags prescribed in these regulations shall be rectangular.
2. The colours of the boards, flags and pennants shall not be faded or dirty.
3. They shall be large enough to be easily visible; this condition shall be considered to be satisfied in all cases:
 - (a) For the boards and flags if neither the length nor the width is less than 1 m or, in the case of small craft, less than 0.60 m;
 - (b) For the pennants if the length is not less than 1 m and the breadth at the staff not less than 0.50 m.

Article 3.04 - Cylinders, balls, cones and bicones

1. The cylinders, balls, cones and bicones prescribed in these regulations may be replaced by devices having the same appearance when seen from a distance.
2. Their colours shall not be faded or dirty.
3. They shall be large enough to be easily visible; this condition shall be considered to be satisfied in all cases:
 - (a) For cylinders, if the height is not less than 0.80 m and the diameter not less than 0.50 m;
 - (b) For balls, if the diameter is not less than 0.60 m;
 - (c) For cones, if the height is not less than 0.60 m and the diameter at the base not less than 0.60 m;
 - (d) For bicones, if the height is not less than 0.80 m and the diameter at the base not less than 0.50 m.

Article 3.05 - Prohibited lights and signals

1. The use of any lights or signals other than those mentioned in these regulations or the use of those mentioned otherwise than as prescribed or permitted by these regulations is prohibited.
2. However, for communication between vessels or between a vessel and the shore, the use of other lights or signals is permitted provided they are not liable to be confused with those mentioned in these regulations.

Article 3.06 - Emergency lights

When signal lights prescribed by these regulations cease to function, they shall be replaced by emergency lights without delay. However, where the prescribed light is strong, the emergency light may be bright and, where the prescribed light is bright, the emergency light may be ordinary. Lights of the prescribed power shall be brought into operation again as soon as possible.

Article 3.07 - Prohibited use of lamps, searchlights, boards, flags, etc.

1. The use of lamps or searchlights or of boards, flags or other objects in such a way that they may be confused with the lights or signals mentioned in these regulations or impair their visibility or complicate their identification is prohibited.
2. The use of lamps or searchlights in such a way that they cause dazzle constituting a danger or inconvenience to navigation or to traffic on the banks of the waterway is prohibited.

II. NIGHT AND DAY MARKING¹

II.A. MARKING WHEN UNDER WAY

Article 3.08 - Marking for motorized vessels proceeding alone

1. Single motorized vessels shall carry:

By night:

(a) A masthead light forward and in the axis of the vessel, at a height of not less than 5 m;²

(b) Side lights, each placed at the same height and on the same perpendicular to the axis of the vessel, 1 m lower than the masthead light and not forward of it; they shall be screened inboard so that the green light cannot be seen from the port side and the red light cannot be seen from the starboard side;

(c) A stern light, placed aft and in the axis of the vessel high enough to be clearly visible to an overtaking vessel.³

¹ Under the national navigational rules of Belarus, Kazakhstan, Lithuania, the Republic of Moldova, the Russian Federation and Ukraine, vessels under way are not required to carry day markings.

² The competent authorities may prescribe a height of less than 5 m.

³ The competent authorities of Belarus, Kazakhstan, the Republic of Moldova, the Russian Federation and Ukraine may prescribe other stern lights.

2. A single motorized vessel may in addition carry by night at the stern a second masthead light placed in the axis of the vessel and at least 3 m higher than the forward light, in such a way that the horizontal distance between these lights is at least three times the vertical distance. A single motorized vessel more than 110 m long shall be required to carry this second masthead light.

3. A single motorized vessel temporarily preceded by night by an auxiliary motorized vessel shall continue to show the lights referred to in paragraphs 1 and 2 above.

When a motorized vessel is preceded by day by one or more auxiliary motorized vessels, it shall carry a yellow ball as indicated in article 3.09, paragraph 3.

4. When passing through the opening of a fixed or closed bridge or weir, or when passing through locks, vessels may carry the masthead lights provided for in paragraphs 1 and 2 above at a reduced height so that passage may be effected without difficulty.

5. The provisions of this article shall not apply to small craft or ferry-boats.

Article 3.09 - Marking for towed convoys under way

1. A motorized vessel leading a towed convoy, and a motorized vessel used as an auxiliary in front of another motorized vessel, a pushed convoy or a side-by-side formation shall carry:

By night:

(a) Two masthead lights one above the other about 1 m apart, placed forward and in the axis of the vessel, the upper light being at least 5 m¹ higher and the lower light, so far as possible, at least 1 m higher than the side lights;

(b) The side lights prescribed in article 3.08, paragraph 1 (b);

(c) A yellow instead of a white stern light, placed in the axis of the vessel and high enough to be clearly visible from the towed unit following the vessel or the motorized vessel, pushed convoy or side-by-side formation in front of which the vessel is used as an auxiliary;

By day:

A yellow cylinder, with two black and white stripes at top and bottom, the white stripes being at the ends of the cylinders. The cylinder shall be placed vertically forward, and high enough to be visible from all directions.

¹ The competent authorities may prescribe a height of less than 5 m.

2. Where a towed convoy is led by several motorized vessels, or where a motorized vessel, pushed convoy or side-by-side formation is preceded by several auxiliary motorized vessels proceeding side by side, whether coupled or not, each of those vessels shall carry:

By night:

Instead of the masthead lights prescribed in 1 (a) above, three masthead lights one above the other about 1 m apart, placed forward in the axis of the vessel, the top and bottom lights being at the same height as those prescribed in paragraph 1 (a);

By day:

The cylinder prescribed in paragraph 1 above.

Where a vessel, an assembly of floating material or a floating establishment is being manoeuvred by more than one motorized vessel, this requirement shall apply to each of them.

3. Vessels in a towed convoy following the motorized vessel or vessels referred to in paragraphs 1 and 2 above shall carry:

By night:

A bright white light visible from all directions, placed at a height of at least 5 m;¹

By day:

A yellow ball in a suitable position and high enough to be visible from all directions.

However,

(a) If a section of the convoy is more than 110 m long, that section shall carry two such lights, one forward and one aft;

(b) If a section of the convoy comprises a row of more than two vessels coupled side by side, only the two outside vessels of the row shall carry such lights or such a ball.

The marking of all towed vessels in a convoy shall so far as possible be carried at the same height above the water level.

4. The vessel or vessels forming the last section of a towed convoy shall carry, in addition to the marking prescribed in paragraph 3 above:

¹ The competent authorities may prescribe a height of less than 5 m.

By night:

The stern light prescribed in article 3.08, paragraph 1 (c).

However, if the convoy ends with a row of more than two vessels coupled side by side, only the two outside vessels of the row shall carry such lights. If the rear of the convoy is made up of small craft, those craft shall not be taken into account for the provisions of this paragraph.

5. When passing through the opening of a fixed or closed bridge or weir, or when passing through locks, the vessels of a towed convoy may carry the lights prescribed in paragraphs 1 (a), 2 and 3 of this article at a reduced height so that passage may be effected without difficulty.

6. Where the vessels referred to in paragraph 3 above are seagoing vessels coming directly from or leaving for the sea, they may carry:

By night:

Instead of the white light, the side lights prescribed in article 3.08, paragraph 1 (b);

By day:

The yellow ball.

7. The provisions of this article shall not apply to small craft towing only other small craft or to the towing of small craft.

Article 3.10 - Marking for pushed convoys under way

1. Pushed convoys shall carry:¹

By night:

- (a) (i) Three masthead lights at the bow of the leading vessel or the vessel on the port side at the head of the convoy. These lights shall be arranged in an equilateral triangle with a horizontal base, in a plane perpendicular to the longitudinal axis of the convoy. The top light shall be at a height of not less than 5 m.² The two lower lights shall be about 1.25 m apart and about 1.10 m below the top light.
- (ii) A masthead light at the bow of any other vessel whose full width is visible from ahead. This light shall so far as possible be 3 m below the top light referred to under (i).

¹ The competent authorities may prescribe the use of bright lights on narrow waterways.

² The competent authorities may prescribe a height of less than 5 m.

The masts carrying these lights shall be in the longitudinal axis of the vessel in which they are carried;¹

(b) The side lights prescribed in article 3.08, paragraph 1 (b); these lights shall be placed on the widest part of the convoy, as near the pusher as possible, not more than 1 m from the sides of the convoy and at a height of not less than 2 m;

(c) (i) Three stern lights as prescribed in article 3.08, paragraph 1 (c) on the pusher, placed in a line perpendicular to its longitudinal axis, about 1.25 m apart and high enough not to be hidden by another vessel in the convoy;

(ii) A stern light on every vessel whose full width is visible from astern; however, when more than two vessels other than the pusher are visible from astern, this light shall be carried only by the two vessels on the outside of the convoy.

2. The provisions of paragraph 1 above shall also apply to pushed convoys preceded by night by one or more auxiliary motorized vessels; however, the stern lights referred to in paragraph 1 (c) (i) above shall be yellow instead of white.

When a pushed convoy is preceded by day by one or more auxiliary motorized vessels, the pusher shall carry the yellow ball referred to in article 3.09, paragraph 3.

3. When a pushed convoy is passing through the opening of a fixed or closed bridge or weir, or when passing through locks, the masthead lights prescribed in paragraph 1 (a) above may be carried at a reduced height so that passage may be effected without difficulty.

4. Pushed convoys with two pushers in side-by-side formation shall carry by night the stern lights prescribed in paragraph 1 (c) (i) on the pusher at the starboard side; the other pusher shall carry the stern light prescribed in paragraph 1 (c) (ii) above.

Article 3.11 - Marking for side-by-side formations under way

1. Side-by-side formations shall carry:

By night:

(a) The masthead light prescribed in article 3.08, paragraph 1 (a), on each vessel; however, each non-motorized vessel may, instead of the masthead light, carry the white light prescribed in article 3.09, paragraph 3, visible from all directions, in a suitable position but not higher than the masthead light of the motorized vessel or vessels;

¹ The competent authorities of Belarus, Kazakhstan, the Republic of Moldova, the Russian Federation and Ukraine may authorize the pusher to carry the mast-head lights and the side lights.

(b) The side lights prescribed in article 3.08, paragraph 1 (b); these lights shall be placed on the outside of the formation, so far as possible at the same height and at least 1 m below the lowest masthead light;

(c) The stern light prescribed in article 3.08, paragraph 1 (c), on each vessel.

2. The provisions of paragraph 1 above shall also apply to side-by-side formations preceded by night by one or more auxiliary motorized vessels.

When a side-by-side formation is preceded by day by one or more auxiliary motorized vessels, each vessel in the formation shall carry the yellow ball referred to in article 3.09, paragraph 3.

3. When a side-by-side formation is passing through the opening of a fixed or closed bridge or of a weir, or when passing through locks, the lights prescribed in paragraph 1 (a) above may be carried at a reduced height so that passage may be effected without difficulty.

4. The provisions of this article shall not apply to small craft propelling only small craft in a side-by-side formation, or to small craft so propelled.

Article 3.12 - Marking for sailing vessels under way

1. Sailing vessels shall carry:

By night:

(a) The side lights prescribed in article 3.08, paragraph 1 (b); however these lights may be ordinary, instead of bright;

(b) The stern light prescribed in article 3.08, paragraph 1 (c).

2. In addition to the lights prescribed in paragraph 1 of this article, a sailing vessel may carry:

By night:

Two ordinary or bright lights one above the other, visible from all directions, the upper light being red and the lower green; these lights shall be in a suitable position at the top or on the upper part of the mast and not less than 1 m apart.

3. All vessels under sail and simultaneously using their own mechanical means of propulsion shall carry:

By day:

A black cone, point downwards.

This cone shall be positioned as high as possible and where it will be most obvious.¹

¹ The competent authorities may waive this provision for isolated waterways.

4. The provisions of paragraphs 1 and 2 of this article shall not apply to small craft. The provisions of paragraph 2 shall not apply to the vessels referred to in article 3.35.

Article 3.13 - Marking for small craft under way

1. Small motorized craft proceeding alone shall carry:

By night:

(a) A masthead light; this light shall be in the axis of the craft, at least 1 m higher than the side lights, and shall be bright instead of strong;¹

(b) Side lights; these lights may be ordinary instead of bright and shall be placed either:

(i) As prescribed in article 3.08, paragraph 1 (b); or

(ii) Side by side or in the same lamp, in the axis of the craft, at or near the bow;

(c) The stern light prescribed in article 3.08, paragraph 1 (c). However, the requirement to carry this light may be waived; but in such case, the masthead light referred to in (a) above shall be a bright white light visible from all directions.

2. Motorized small craft less than 7 m long proceeding alone may carry, instead of the lights prescribed in paragraph 1 above, an ordinary white light in a suitable position and high enough to be visible from all directions.²

3. When a small craft is towing or propelling in side-by-side formation only other small craft, it shall carry by night the lights prescribed in paragraph 1 above.

4. Small craft in tow or propelled in side-by-side formation shall carry by night an ordinary white light visible from all directions. This provision shall not apply to ships' boats.

5. Small sailing craft under way shall carry:

By night:

Side lights and stern light, the side lights being placed side by side or in the same lamp in the axis of the craft, at or near the bow, and the stern light being placed in the after part of the craft; however, these lights may be ordinary lights; or

¹ The competent authorities may also prescribe a mast-head light at the same height as the side lights and not less than 1 m forward of them.

² The competent authorities may limit the scope of this provision to slow or low-powered craft or to certain waterways.

Side lights and a stern light in the same lamp placed in a suitable position at the top or on the upper part of the mast; this light may be an ordinary light; or

In the case of craft less than 7 m long, an ordinary white light visible from all directions. On the approach of other vessels, such craft shall in addition display a second ordinary white light.¹

6. Small craft proceeding alone which are neither motorized nor under sail shall carry:

By night:

An ordinary white light visible from all directions.

However, ships' boats under these conditions need not display this light except on the approach of other vessels.

7. When passing through the opening of a fixed or closed bridge or weir, or when passing through locks, the masthead lights prescribed in this article may be carried at a reduced height so that passage may be effected without difficulty.

Article 3.14 - Additional marking for vessels carrying out certain transport operations involving dangerous substances^{2 3}

1. Vessels carrying out transport operations involving certain flammable substances that are referred to in marginal 10 500 of Annex B.1 and Appendix 4 (list of substances) of Annex B.2 of ADN shall carry, in addition to the marking prescribed elsewhere in these regulations:

By night:

A blue light;

By day:

A blue cone, point downwards.

These markings shall be in a suitable position and high enough to be visible from all directions. The blue cone may be replaced by one blue cone at the bow and one blue cone at the stern of the vessel, at a height of not less than 3 m above the draught markings.

¹ On certain inland waterways the competent authorities may prescribe this provision to all small sailing craft.

² In the case of seagoing vessels operating only temporarily in inland navigation areas, the competent authorities may authorize the use of the day and night signals prescribed in the Recommendations on the Safe Transport of Dangerous Cargoes and Related Activities in Port Areas adopted by the Maritime Safety Committee of the International Maritime Organization (by night an all-round fixed red light and by day flag "B" of the International Code of Signals), instead of the signals prescribed in paragraphs 1, 2 and 3 of this article.

³ The competent authorities of Belarus, Kazakhstan, the Republic of Moldova, the Russian Federation and Ukraine may prescribe red lights instead of blue lights.

2. Vessels carrying out transport operations involving certain substances constituting health hazards that are referred to in marginal 10 500 of Annex B.1 and in Appendix 4 (list of substances) to Annex B.2 of ADN shall carry, in addition to the marking prescribed elsewhere in these regulations:

By night:

Two blue lights;

By day:

Two blue cones, point downwards.

These markings shall be placed one about 1 m above the other, in a suitable position and high enough to be visible from all directions. The two blue cones may be replaced by two blue cones at the bow and two blue cones at the stern of the vessel at a height not less than 3 m above the draught markings.

3. Vessels carrying out transport operations involving certain explosives that are referred to in marginal 10 500 of Annex B.1 of ADN shall carry, in addition to the marking prescribed elsewhere in these regulations:

By night:

Three blue lights;

By day:

Three blue cones, point downwards.

These markings shall be about 1 m one above the other, in a suitable position and high enough to be visible from all directions.

4. When a pushed convoy or side-by-side formation includes one or more of the vessels referred to in paragraphs 1, 2 or 3 above, the marking prescribed in paragraphs 1, 2 or 3 above shall be carried by the vessel propelling the pushed convoy or side-by-side formation.

5. Pushed convoys propelled by two pushers side by side shall carry the marking referred to in paragraph 4 above on the starboard pusher.

6. Any vessel, pushed convoy or side-by-side formation carrying out a transport operation involving several dangerous substances that are referred to in paragraphs 1, 2 and 3 above shall carry the marking corresponding to the substance that requires the greatest number of blue lights or blue cones.

7. Any vessel not required to carry the markings referred to in paragraphs 1, 2 or 3 above but which has been issued with an approval certificate in accordance with marginal 10 282 (Annex B.1) or marginal 210 282 (Annex B.2) of ADN and which conform to the safety provisions for vessels referred to in paragraph 1 above, may, on approaching a lock, display the markings referred to in paragraph 1 above, when it wishes to pass through the lock with a vessel required to display the markings referred to in paragraph 1 above.

8. The intensity of the blue lights prescribed in this article shall be at least equal to that of ordinary blue lights.

Article 3.15 - Marking of vessels authorized to carry more than 12 passengers with a hull length of not more than 20 m¹

Vessels authorized to carry more than 12 passengers with a maximum hull length of not more than 20 m shall carry:

By day:

A yellow bicone in a suitable position and high enough to be visible from all directions.

Article 3.16 - Marking for ferry-boats under way²

1. Ferry-boats not moving independently shall carry:

By night:

(a) A bright white light visible from all directions, at a height of not less than 5 m; this height may, however, be reduced if the ferry-boat is not more than 15 m long;

(b) A bright green light visible from all directions, about 1 m above the light referred to in (a) above;

By day:

A green ball at a height of not less than 5 m.³

2. The leading boat or float of a longitudinal-cable ferry-boat shall carry, by night, not less than 3 m above the water level, a bright white light visible from all directions.

¹ The competent authorities may waive these requirements for vessels which they consider as small craft.

² The competent authorities of Belarus, Lithuania, the Republic of Moldova, the Russian Federation and Ukraine may prescribe another marking.

³ The competent authorities may waive the requirement for day markings or prescribe a height of less than 5 m.

3. Ferry-boats moving independently shall carry:

By night:

- (a) A bright white light visible from all directions, as prescribed in paragraph 1 (a) above;
- (b) A bright green light visible from all directions, as prescribed in paragraph 1 (b) above;
- (c) The side lights and stern light prescribed in article 3.08, paragraphs 1 (b) and (c);

By day:

A green ball, as prescribed in paragraph 1 above.¹

4. Ferry-boats moving independently and enjoying priority shall carry:

By night:

- (a) A bright white light visible from all directions, as prescribed in paragraph 1 (a) above;
- (b) A bright green light visible from all directions, as prescribed in paragraph 1 (b) above;
- (c) A second bright green light visible from all directions, about 1 m above that prescribed in (b) above;
- (d) The side lights and stern light prescribed in article 3.08, paragraph 1 (b) and 1 (c);

By day:

A white cylinder, about 1 m below the green ball prescribed in paragraph 1 above.

Article 3.17 - Additional marking for vessels enjoying priority of passage

Vessels for which the competent authority has authorized priority of passage at points where it regulates the order of passage may carry, in addition to the marking prescribed in other provisions of these regulations:

By day:

A red pennant at the bow and high enough to be clearly visible.

¹ The competent authorities may waive the requirement for day markings or prescribe a height of less than 5 m.

Article 3.18 - Additional marking for vessels unable to manoeuvre

1. A vessel which is unable to manoeuvre shall, if necessary, display, in addition to the marking prescribed elsewhere in these regulations:

By night:

A swinging red light; in the case of small craft, this light may be white instead of red; or

Two red lights, one about 1 m above the other, placed in a suitable position and high enough to be visible from all directions;

By day:

A swinging red flag; or

Two black balls, one about 1 m above the other, placed in a suitable position and high enough to be visible from all directions.

2. If necessary, such vessels shall in addition give the regulation sound signal.

Article 3.19 - Marking for assemblies of floating material and floating establishments under way

Without prejudice to any special conditions which may be imposed under article 1.21, assemblies of floating material and floating establishments shall carry:

By night:

A sufficient number of bright white lights visible from all directions to show their outline.

II.B. MARKING WHEN STATIONARY

Article 3.20 - Marking for stationary vessels¹

1. A vessel directly or indirectly made fast to the bank shall carry:

By night:

On the channel side and at a height of at least 3 m, an ordinary white light visible from all directions.

¹ When vessels, in particular small craft, are stationary in circumstances such that marking is not considered necessary by the competent authorities, the latter may exempt them from the obligation to carry the marking prescribed in this article.

This light may be replaced by an ordinary white light at the bow and an ordinary white light at the stern, positioned at the same height on the channel side and visible from all directions.

2. A vessel stationary offshore (without direct or indirect access to the bank) shall carry:

By night:

Two ordinary white lights visible from all directions and in suitable positions, one forward at a height of at least 4 m and the other aft at a height of at least 2 m and at least 2 m lower than the other;

By day:

A black ball in a suitable position forward and high enough to be visible from all directions.

3. A pushed convoy stationary offshore (without direct or indirect access to the shore) shall carry:

By night:

On each vessel of the formation an ordinary white light visible from all directions, in a suitable position and at a height of at least 4 m. The total number of lights marking the barges shall not exceed four, provided that the outlines of the convoy are clearly marked;

By day:

A black ball on the pusher (or on each pusher) and on the leading vessel of the convoy or on the outermost vessels leading the convoy.

4. Small craft other than ship's boats may carry, instead of the lights prescribed by night in paragraphs 1 and 2 above, an ordinary white light in a suitable position and high enough to be visible from all directions.

5. The marking prescribed in this article shall not be mandatory:

(a) When the vessel is stationary in a waterway on which navigation is temporarily impossible or prohibited;

(b) When the vessel is stationary alongside the bank and is sufficiently well lit from the bank;

(c) When the vessel is stationary outside the channel in a clearly safe situation.

6. This article shall not apply to the vessels referred to in articles 3.22, 3.25, 3.34, paragraph 2, and 3.35.

Article 3.21 - Additional marking for stationary vessels carrying out certain transport operations involving dangerous substances

The requirements of article 3.14 shall also apply to the vessels referred to in that article when those vessels are stationary.

Article 3.22 - Marking for ferry-boats made fast at their landing-stage

1. Ferry-boats not moving independently shall, when made fast at their landing-stage, carry by night the lights prescribed in article 3.16, paragraph 1. In addition, the lead boat or float of a longitudinal-cable ferry-boat shall carry the light prescribed in article 3.16, paragraph 2.
2. Ferry-boats moving independently in service shall, when made fast at their landing-stage, carry by night the lights prescribed in article 3.16, paragraph 1. When made fast for a short time, they may also keep the lights prescribed in article 3.08, paragraph 1 (b) and (c). The green light referred to in article 3.16, paragraph 3 (b) shall be extinguished as soon as the ferry-boat is no longer in service.

Article 3.23 - Marking for assemblies of floating material and floating establishments when stationary

Without prejudice to any special conditions which may be imposed under article 1.21, assemblies of floating material and floating establishments shall carry:

By night:

A sufficient number of ordinary white lights visible from all directions to show their outlines on the channel side.

The provisions of article 3.20, paragraph 5, are applicable.

Article 3.24 - Marking for nets or poles of stationary vessels

When vessels have nets or poles extending into the channel or near to it, such nets or poles shall be marked:

By night:

By ordinary white lights visible from all directions in sufficient number to show their position;

By day:

By yellow floats or yellow flags in sufficient number to show their position.

Article 3.25 - Marking for floating equipment at work and for grounded or sunken vessels

1. Floating equipment at work and stationary vessels carrying out work or sounding or measuring operations shall carry:

(a) On the side or sides on which the channel is clear:

By night:

Two ordinary green lights or two bright green lights;

By day:

Two green bicones, one placed about 1 m above the other; and, as appropriate;

(b) On the side on which the channel is not clear:

By night:

An ordinary red light or a bright red light, placed at the same height as the higher of the two green lights prescribed in (a) above, and of the same intensity;

By day:

A red ball, placed at the same height as the higher of the two green bicones prescribed in (a) above,

or, if the vessels have to be protected against wash,

(c) On the side or sides on which the channel is clear:

By night:

An ordinary red light and an ordinary white light, or a bright red light and bright white light, one placed about 1 m above the other, with the red light at the top;

By day:

A flag with a red upper half and a white lower half, or two flags flown one above the other, the upper flag being red and the lower flag white,

and, as appropriate,

(d) On the side on which the channel is not clear:

By night:

A red light at the same height and of the same intensity as the red light prescribed in (c) above.

By day:

A red flag at the same height as the red and white flag or red flag flown on the other side.

2. The marking prescribed by day in paragraph 1 (a) and (b) above may be replaced by the following signs:

(a) On the side or sides on which the channel is clear, the “entry permitted” board E.1 (annex 7);

and, as appropriate,

(b) On the side on which the channel is not clear, the “no entry” board A.1 (annex 7), placed at the same height as the board prescribed in (a) above.

3. The marking prescribed in paragraphs 1 and 2 above shall be placed high enough to be visible from all directions.

The flags may be replaced by boards of the same colour.

4. Grounded or sunken vessels shall carry the marking prescribed in paragraph 1 (c) and (d) above. If the position of a sunken vessel prevents the marking from being placed on the vessel, it shall be placed on boats or buoys or displayed in any other appropriate manner.

5. The competent authorities may waive the obligation to carry the lights prescribed in paragraphs 1 and 2 above under (a) and (b).

Article 3.26 - Marking for anchors that may be a danger to navigation

1. When, in the cases referred to in articles 3.20 and 3.23, by night, the anchors of vessels, assemblies of floating material or floating establishments are so placed that they, their cables or chains may be a danger to navigation, the “stationary vessel” light nearest to such anchors shall be replaced by two ordinary white lights visible from all directions, one about 1 m above the other.

2. The vessels, assemblies of floating material and floating establishments shall mark each of their anchors which might be a danger to navigation:

By night:

By a float with a radar reflector bearing an ordinary white light visible from all directions;¹

By day:

By a yellow float with a radar reflector.

III. SPECIAL MARKING

Article 3.27 - Additional marking for vessels of the supervising authorities and fire-fighting services

Vessels of the supervising authorities may, without prejudice to the marking applicable to them under the other provisions of these regulations, display:

By day and by night:

An ordinary blue scintillating light visible from all directions.

This shall apply also to fire-fighting vessels when on their way to bring assistance.²

Article 3.28 - Additional marking for vessels under way carrying out work in the waterway³

Vessels under way carrying out work in the waterway or engaged in sounding or measuring operations may, without prejudice to the marking applicable to them under the other provisions of these regulations, display:

By day and by night:

A bright or ordinary yellow scintillating light visible from all directions.

The use of this marking shall be restricted to vessels having written authorization from the competent authorities.

¹ The competent authorities may waive the requirement for a white light or prescribe such a light only for floating equipment.

² The competent authorities may also require these lights for rescue craft.

³ The competent authorities may waive this requirement.

Article 3.29 - Additional marking for protection against wash

1. Vessels, assemblies of floating material and floating establishments under way or stationary (other than those specified in article 3.25) requiring protection against wash caused by the passage of other vessels or assemblies of floating material may, without prejudice to the marking applicable to them under the provisions of the other articles of this chapter, display:

By night:

An ordinary red light and an ordinary white light, or a bright red light and a bright white light, one about 1 m above the other with the red light above, and in such a position that they are clearly visible and cannot be confused with other lights;

By day:

A flag with a red upper half and the lower half white, in a suitable position and high enough to be visible from all directions. This flag may be replaced by two flags one above the other, the upper flag red and the lower flag white. These flags may be replaced by boards of the same colour.

2. Without prejudice to the provisions of article 3.25, only the following may use the marking mentioned in paragraph 1 above:

(a) Vessels, assemblies of floating material and floating establishments which are seriously damaged or are engaged in rescue work, and vessels unable to manoeuvre;

(b) Vessels, assemblies of floating material and floating establishments having written authorization from the competent authorities.

Article 3.30 - Distress signals

1. When a vessel in distress needs assistance, it may display:

- (a) A flag or any other suitable object waved in a circle;
- (b) A flag having above or below it a ball or anything resembling a ball;
- (c) A light waved in a circle;
- (d) Rockets or shells throwing red stars, fired one at a time at short intervals;
- (e) A luminous signal consisting of the group ... --- ... (SOS) in Morse Code;
- (f) Flames such as may be produced by burning tar, oil, etc.;
- (g) Parachute flares or hand-held flares emitting a red light;
- (h) Slow, repeated up-and-down movements of the arms extended on each side.

2. These signals replace or supplement the sound signals referred to in article 4.01, paragraph 4.

Article 3.31 - Prohibition of boarding

1. If there are regulations prohibiting unauthorized persons from going on board, the prohibition shall be indicated by:

Circular white boards bordered with red, with a red diagonal and the figure of a pedestrian in black.

The boards shall be placed on the vessel or on the gangway, as circumstances require. By derogation from article 3.03, paragraph 3, they shall be about 60 cm in diameter.

2. The boards shall be illuminated, as required, so as to be clearly visible at night.

Article 3.32 - Prohibition of smoking

1. If there are regulations prohibiting smoking on board, the prohibition shall be indicated by:

Circular white boards bordered with red, with a red diagonal and a picture of a cigarette emitting smoke.

The boards shall be placed on the vessel or on the gangway, as circumstances require. By derogation from article 3.03, paragraph 3, they shall be about 60 cm in diameter.

2. The boards shall be illuminated, as required, so as to be clearly visible at night.

Article 3.33 - Prohibition of lateral berthing

1. If there are regulations or special requirements laid down by the competent authorities prohibiting lateral berthing near a vessel (for instance because of the nature of its cargo) that vessel shall carry on deck, in the longitudinal axis:

A square board with a triangle below.

Both faces of the square board shall be white with a red border, and have a red diagonal from the top left to the bottom right with the letter 'P' in black in the centre.

Both faces of the triangle shall be white and show in black figures the distance in metres over which berthing is prohibited.

2. By night, the boards shall be illuminated so as to be clearly visible on both sides of the vessel.
3. This article shall not apply to the vessels, pushed convoys or side-by-side formations referred to in article 3.21.

Article 3.34 - Additional marking for vessels whose ability to manoeuvre is limited

1. A vessel whose capacity to give way in accordance with the requirements of these regulations is limited when it is carrying out work or underwater operations such as dredging or cable or buoy laying, and whose position may hinder navigation shall carry, in addition to the marking prescribed elsewhere in these regulations:

By night:

Three bright or ordinary lights, the top and bottom lights red and the middle light white, one above the other not less than 1 m apart and high enough to be visible from all directions;

By day:

A black ball, a black bicone and a black ball, the bicone in the middle, one above the other not less than 1 m apart and high enough to be visible from all directions.

2. When the operation in which they are engaged causes an obstruction, the vessels referred to in paragraph 1 shall carry, in addition to the marking prescribed in paragraph 1:

By night:

(a) Two bright or ordinary red lights, one above the other not less than 1 m apart, on the side or sides on which the obstruction occurs, such as to be visible from all directions;

(b) Two bright or ordinary green lights, one above the other not less than 1 m apart, on the side or sides on which the channel is clear, such as to be visible from all directions;

By day:

(a) Two black balls, one above the other not less than 1 m apart, on the side or sides on which the obstruction occurs;

(b) Two black bicones, one above the other not less than 1 m apart, on the side or sides on which the channel is clear.

The lights, balls and bicones referred to in this paragraph shall be placed not less than 2 m from, and in no case higher than, the lower light or ball referred to in paragraph 1 of this article.

3. The provisions of this article shall not apply to floating equipment at work when stationary.

Article 3.35 - Additional marking for vessels engaged in fishing¹

1. A vessel engaged in drawing a trawl or other fishing gear through the water (trawler) shall carry, in addition to the marking prescribed elsewhere in these regulations:

By night:

Two bright or ordinary lights, the upper light green and the lower light white, one above the other, not less than 1 m apart and high enough to be visible from all directions, forward of the light prescribed in article 3.08, paragraph 1 (a), the upper light lower than that light and the lower light at a height above the lights prescribed in article 3.08, paragraph 1 (b) at least twice the vertical distance referred to above; however, vessels less than 50 m long shall not in this case be required to carry the light prescribed in article 3.08, paragraph 1 (a);

By day:

Two black cones, point to point, one above the other and high enough to be visible from all directions.

2. Vessels engaged in fishing other than the vessels referred to in paragraph 1 shall carry the marking prescribed in that paragraph, except for the light prescribed in article 3.08, paragraph 1 (a) and, in place of the green light:

By night:

A bright or ordinary red light, such as to be visible from all directions;

and in addition, if the fishing tackle extends more than 150 m horizontally from the vessel, in line with the tackle:

By night:

A bright or ordinary white light, at a horizontal distance not less than 2 m and not more than 6 m from the two red and white lights prescribed above and at such a height as to be neither above the white light nor lower than the lights prescribed in article 3.08, paragraph 1 (b);

By day:

A black cone, point upwards.

¹ In applying the marking stipulated in this article, the competent authorities shall avoid any confusion with the markings stipulated in article 3.16.

Article 3.36 - Additional marking for vessels used for underwater diving

1. A vessel being used for underwater diving shall carry, in addition to the marking prescribed elsewhere in these regulations:

A rigid reproduction at least 1 m high of the "A" flag of the International Code of Signals, in a suitable position and high enough to be visible from all directions by night and day.

2. Where appropriate, such vessels may carry the marking referred to in article 3.34, paragraph 1, instead of the marking prescribed in paragraph 1 above.

Article 3.37 - Additional marking for vessels engaged in minesweeping

A vessel engaged in minesweeping shall carry, in addition to the marking prescribed elsewhere in these regulations:

By night:

Three bright or ordinary green lights visible from all directions, arranged in a triangle with a horizontal base in a plane perpendicular to the axis of the vessel, the top light at or near the top of the foremast and the other lights at each end of the foremast yard;

By day:

Three black balls arranged in the manner prescribed for the lights.

Article 3.38 - Additional marking for vessels on pilotage service

A vessel on pilotage service shall carry, in addition to the marking prescribed elsewhere in these regulations:

Instead of the light prescribed in article 3.08, paragraph 1 (a), two bright or ordinary lights one above the other and visible from all directions, the top light white and the lower light red, at or near the top of the mast.

Chapter 4

SOUND SIGNALS ON VESSELS - RADIOTELEPHONY

Article 4.01 - General

1. When sound signals other than bells are prescribed in these regulations or any other provisions applicable, they shall be given:

(a) On motorized vessels, except certain small craft unless these are vessels with radar equipment, by means of mechanically operated sound signalling devices, placed sufficiently high that the sound signals can spread freely to the front and if possible also to the back; the signalling devices shall conform to the requirements laid down in chapter I of annex 6 of these regulations.

(b) On non-motorized vessels and motorized small craft whose equipment does not include a sound signalling device, by means of a suitable trumpet or horn; such sound signals shall conform to the requirements of chapter I, paragraphs 1 (b) and 2 (b), of annex 6 to these regulations.

2. The sound signals given by motorized vessels shall be accompanied by light signals synchronized with them, such light signals shall be yellow, bright and visible from all directions. This provision shall not apply to small craft or to the signal prescribed in article 6.32, paragraph 4 (a) (Class I), to be given by vessels proceeding downstream and navigating by radar, or to be ringing or pealing of a bell.^{1 2}

3. Unless specifically provided to the contrary, in the case of a convoy, prescribed sound signals need be given, only by the vessel carrying the boatmaster of the convoy.³

4. When a vessel in distress needs assistance, it may ring a bell or sound repeated long blasts. Such signals may replace or supplement the visual signals referred to in article 3.30.

¹ The competent authorities may make this provision compulsory; but, if they avail themselves of that right, they shall exempt vessels registered in States where the same rule does not apply.

² The competent authorities may waive this requirement on certain waterways where Rule 34 (b) and (d) of the International Regulations for Preventing Collisions at Sea is applicable.

³ The competent authorities may prescribe that, if a temporary auxiliary tug is at the head of the convoy, the signals shall be given, or shall also be given, by that tug.

5. To ensure the audibility of sound signals, the weighted sound pressure level in the wheelhouse in the area of the helmsman's head shall not exceed 70 dB (A) when the vessel is proceeding under normal conditions.¹

6. A bell peal shall last about four seconds. It may be replaced by the repeated striking of metal on metal over the same duration.

Article 4.02 - Use of sound signals

1. Without prejudice to the other provisions of these regulations, all vessels except the small craft referred to in paragraph 2 of this article shall, when necessary, use the signals specified in chapter III of annex 6 to these regulations.

2. Small craft proceeding alone or towing or propelling in side-by-side formation only small craft may, if necessary, give the general signals specified in chapter III A of annex 6 to these regulations.

Article 4.03 - Prohibited sound signals

1. The use of sound signals other than those mentioned in these regulations, or the use of the signals mentioned otherwise than as prescribed or permitted by these regulations, is prohibited.

2. However, for communication between vessels or between the vessel and the shore, the use of other sound signals is permitted provided that they are not liable to be confused with those mentioned in these regulations.

Article 4.04 - Radiotelephony²

1. Every radiotelephone set carried on board a vessel or floating establishment shall conform to, and shall be operated in accordance with, the requirements of the competent authorities.³

2. Motorized vessels, excluding small craft, ferries and floating equipment may sail only if they are equipped with two radiotelephone installations in proper working order. When under way, the radiotelephone installations for the ship-to-ship and nautical information channels must be permanently in a ready-to-transmit and ready-to-receive state. The channel allocated to nautical information may only be left for a short time in order to transmit or receive information on other channels.

¹ The competent authorities may authorize a sound-pressure level of 75 dB (A).

² The competent authorities may waive the provisions of this article for certain inland waterways where there is no international traffic.

³ The telecommunication services of a number of ECE member Governments have harmonized their national technical and operational requirements for radiotelephone installations on board inland navigation vessels in the framework of a Regional Arrangement based on the Radio Regulations of the International Telecommunication Union (ITU).

3. Ferry-boats and motorized floating equipment may only sail if they are equipped with a radiotelephone installation in proper working order. When under way, the radiotelephone installation for the ship-to-ship channel must be permanently in a ready-to-transmit and ready-to-receive state. This channel may only be left for a short time in order to transmit or receive information on other channels. The first and the second sentence shall also apply during operation.
4. Each vessel equipped with a radiotelephone installation shall make reports on the channel allocated to the ship-to-ship network before entering blind sections, narrow channels or bridge openings.
5. Sign B.11 (Annex 7) shall indicate that the competent authority requires the use of radiotelephone communications.

Chapter 5

WATERWAY SIGNS AND MARKING

Article 5.01 - Signs

1. Annex 7 to these regulations sets out the prohibitory, mandatory, restrictive, recommendatory and informative signs and auxiliary signs for inland waterways.¹ It also defines the meaning of each sign.

2. Without prejudice to the other provisions of these regulations or to any other provisions applicable,² including the special instructions referred to in article 1.19, boatmen shall obey the rules and take account of the recommendations and information conveyed to them by the signs referred to in paragraph 1 above on the waterway or its banks.

Article 5.02 - Marking

Annex 8 to these regulations defines the marking which may be used to facilitate navigation. It also specifies the circumstances in which the various marks are to be used.

¹ The competent authorities may omit from their regulations those signs in annex 7 which they do not install on the waterways to which those regulations apply.

² In particular, the competent authorities may, where necessary, regulate navigation on certain sections by also using special signs at control posts.

Chapter 6

RULES OF THE ROAD

A. GENERAL

Article 6.01 - Definitions

1. For the purposes of this chapter, the following waterways are in Class I:¹
.....
All other waterways are in Class II.

2. For the purposes of this chapter, “upstream” on a navigational channel means the direction towards the source of the river, including sections where the current changes with the tide.

On canals, the direction shall be determined by the competent authorities and the term “in the direction from point A to point B” shall be used.²

3. For the purposes of this chapter, the following terms are used:

(a) “Meeting”: where two vessels are proceeding on courses directly or almost directly opposite;

¹ Class I normally comprises rivers, and Class II canals, lakes and broad waterways.

² The competent authorities may group the particulars given in paragraphs 1 and 2 above in a single table such as the following:

1. The following are Class I waterways:

<i>Waterways</i>	<i>“Upstream”</i>
River A	Towards source
River B	Towards source; but downstream from ... against tidal current
Canal C-D	Towards C

All other waterways are in Class II.

2. On the following Class II waterways, the upstream direction for the purposes of articles 6.08, paragraph 1, and 6.12 is as follows:

River A	Towards source
Canal B-C (canal with summit-level section)	From B and C towards ... lock on summit level section.

(b) “Overtaking”: where a vessel (the overtaking vessel) comes up to another vessel (the vessel being overtaken) from a direction more than 22.5° abaft the latter vessel’s beam and overtakes it;

(c) “Crossing”: where two vessels are approaching in a situation other than the cases referred to under (a) and (b).

Article 6.01 bis - High-speed vessels

Hydrofoils and hovercraft are required to leave all other vessels enough room to hold their course and to manoeuvre; they may not require such vessels to give way to them.^{1 2}

Article 6.02 - Small craft: General rule

1. For the purposes of this chapter, the term “small craft” means small craft navigating alone or convoys consisting only of small craft.

2. Where the provisions of this chapter provide that a particular rule of the road shall not apply to small craft in relation to other vessels, it shall be incumbent on small craft to leave all other vessels, except the vessels referred to in article 6.01 *bis*, enough room to hold their course and to manoeuvre; small craft may not require other vessels to give way to them.

B. MEETING, CROSSING AND OVERTAKING

Article 6.03 - General principles

1. Crossing or overtaking is permitted only when the channel is unquestionably wide enough for simultaneous passage, taking all the local circumstances and movements of other vessels into account.

2. When vessels are proceeding in convoy, the visual signals prescribed in articles 3.17, 6.04 and 6.05 shall be shown or emitted only by the vessel carrying the boatmaster of the convoy or side-by-side formation or, in the case of a towed convoy, by the towed vessel at the head of the convoy.

3. Vessels on courses which preclude all danger of collision shall not change their course or their speed in a manner which might give rise to danger of collision.

¹ The competent authorities may apply this provision for other categories of vessel navigating at high speed.

² The competent authorities may require vessels navigating at high speed to indicate in good time by appropriate signals on what side they intend to pass.

4. When, on meeting or crossing, one vessel is required to give way to another, that other vessel shall maintain its course and speed. When, for any reason, the vessel which is required to maintain its course and speed finds itself so near the other vessel that a collision cannot be avoided solely by a manoeuvre on the part of the vessel required to give way, it shall manoeuvre in the manner that can best help to avoid a collision.¹

Article 6.03 bis - Crossing

1. When two vessels are crossing in such manner that there is a risk of collision, the vessel which has the other vessel to starboard shall give way to it and, if circumstances permit, avoid crossing ahead of it. However, the vessel which is on the starboard side of a marked channel, shall maintain its course. This rule shall not apply to small craft in relation to other vessels.

2. The provision in paragraph 1 shall not apply when any one of articles 6.13, 6.14 or 6.16 is applicable.

3. Notwithstanding anything to the contrary in paragraph 1 above, when, in the case of small craft of different categories, two small craft are crossing in such a manner that there is a risk of collision, motorized small craft shall give way to all other small craft and small craft neither motorized nor under sail shall give way to small craft under sail.

However, the craft which is on the starboard side of the channel shall maintain its course.

4. Notwithstanding anything to the contrary in paragraph 1 above, when, in the case of vessels under sail, two vessels are crossing in such a manner that there is a risk of collision, one of them shall give way to the other as follows:

(a) When each vessel has the wind on a different side, the vessel with the wind on the port side shall give way to the other;

(b) When both vessels have the wind on the same side, the vessel which is to windward shall give way to the vessel to leeward;

(c) If a vessel which has the wind on the port side sees another vessel to windward and cannot determine with certainty whether the other vessel has the wind on the port or on the starboard side, the first shall give way to the other.

However, the vessel which is on the starboard side of the channel shall maintain its course.

This paragraph does not apply to small craft in relation to other vessels.

¹ The competent authorities may waive this provision.

Article 6.04 - Meeting: Normal rules

CLASS I

1. When meeting, vessels proceeding upstream shall, with due regard for local circumstances and the movements of other vessels, give way to vessels proceeding downstream.

2. Vessels proceeding upstream which leave the course of those proceeding downstream on their port side give no signal.

3. Vessels proceeding upstream which leave the course of those proceeding downstream on their starboard side shall in good time and to starboard:

(a) By day:

- Display a strong scintillating white light or wave a light blue flag or board; or
- Display a light blue board in conjunction with a bright scintillating white light;

(b) By night:

- Display a bright scintillating white light in conjunction, if desired, with a light blue board.

These signals shall be visible from ahead and from astern and be displayed until passing is completed. Their continued display after passing is completed is prohibited unless it is desired to indicate an intention to continue allowing vessels proceeding downstream to pass to starboard. The light blue board shall have a white border not less than 5 cm wide; the frame and lath structure and the lantern of the scintillating light shall be dark in colour.

CLASS II

1. When two vessels are meeting and there may be a risk of collision, each vessel shall veer to starboard so as to pass on the port side of the other

This rule does not apply to small craft in relation to other vessels.

2. Vessels proceeding upstream which leave the course of those proceeding downstream on their port side give no signal.

3. Notwithstanding anything to the contrary in paragraph 1 above, in the case of sailing vessels meeting, article 6.03 *bis*, paragraph 4, shall apply.

4. As soon as it appears that the intentions of a vessel proceeding upstream may not have been understood by a vessel proceeding downstream, the vessel proceeding upstream shall sound:

- One short blast when the meeting is to be to port; and
- Two short blasts when the meeting is to be to starboard.

5. Without prejudice to the provisions of article 6.05 below, vessels proceeding downstream shall follow the course indicated by those proceeding upstream in accordance with the above provisions; they shall repeat the visual signals referred to in paragraph 3 above or the sound signals referred to in paragraph 4 above made to them by vessels proceeding upstream.

6. Paragraphs 1 to 5 above shall not apply to small craft in relation to other vessels or to small craft meeting other small craft.

7. In the case of two small craft meeting, article 6.04, Class II, shall apply.

Article 6.05 - Meeting: Departures from normal rules

CLASS I

1. By derogation from the provisions of article 6.04, vessels or towed convoys in one of the following categories:

CLASS II

1. By derogation from the normal rule set out in article 6.04, vessels may in exceptional cases, and if certain that their request can be safely met, ask to pass starboard to starboard.¹

¹ The competent authorities may explicitly limit these exceptional cases, for example, to:

- Light vessels which, owing to a side wind, cannot keep to the right;
- Vessels which have to stop at the bank on their left;
- Vessels which have to enter a port, a tributary waterway, a lock or the opening of a bridge on the left.

(a) Passenger vessels providing a regular service and whose authorized maximum passenger capacity is not below a number prescribed by the competent authority, when proceeding downstream and wishing to call at a landing-stage on the side used by vessels proceeding upstream; and

(b) Towed convoys proceeding downstream which wish to keep close to a particular bank in order to turn upstream have the right to ask vessels proceeding upstream to change the course left clear for them in accordance with article 6.04 above if that course does not suit them.

However, they may not so ask unless certain that their request can be safely met.

2. In such cases, the vessels proceeding downstream shall give the following signals in good time:

If they wish to pass to port, one short blast;

If they wish to pass to starboard, two short blasts and, in addition, the visual signals referred to in article 6.04, paragraph 3.

3. Vessels proceeding upstream shall then grant the request of those proceeding downstream and confirm the fact as follows:

- If they are to pass to port, by sounding one short blast and, in addition, removing the visual signals referred to in article 6.04, paragraph 3;

2. In such cases, they shall sound two short blasts and, in addition, display the visual signals prescribed in article 6.04, paragraph 3 (a) and (b) (Class I). These signals shall be visible from ahead and from astern and be displayed until passing is completed. Their continued display after passing is completed is prohibited unless it is desired to indicate an intention to continue allowing vessels to pass to starboard.¹

3. The vessels met shall then also sound two short blasts and leave the necessary space to starboard. They shall at the same time show the visual signals referred to in article 6.04, paragraph 3 (Class I) above.²

¹ The competent authorities may decide not to prescribe these visual signals.

² *Idem.*

- If they are to pass to starboard, by sounding two short blasts and, in addition, displaying the visual signals referred to in article 6.04, paragraph 3.

4. As soon as it appears that the intentions of a vessel proceeding downstream may not have been understood by a vessel proceeding upstream, the vessel proceeding downstream shall repeat the sound signals referred to in paragraph 3 of this article.

4. If the vessel met sees that the course requested is unsuitable and that there is a danger of collision, it shall sound a series of very short blasts. The steersmen shall then take all the steps required by the situation to obviate the danger.

5. If a vessel proceeding upstream sees that the course requested by one proceeding downstream is unsuitable and will cause a danger of collision, it shall sound a series of very short blasts. The steersmen shall then take all the steps required by the situation to obviate the danger.

6. Paragraphs 1 to 5 above shall not apply to small craft in relation to other vessels or to small craft meeting other small craft.

Article 6.06 - Meeting boats towed from the bank

In the event of a meeting between a vessel being towed from the bank and a vessel not being so towed, the latter shall, by derogation from articles 6.04 and 6.05, always leave the towing side to the former.

Article 6.07 - Meeting in narrow channels

1. In order to avoid so far as possible meetings on sections or at points where the channel is not unquestionably wide enough for vessels to pass (narrow channels), the following rules shall apply:

- (a) All vessels shall proceed through narrow channels as quickly as possible;
- (b) Where the view is restricted, vessels shall sound one long blast before entering a narrow channel; if necessary, especially when the narrow channel is long, they shall repeat this signal while passing through it.
- (c) On waterways for which “downstream” and “upstream” are defined:
 - (i) A vessel proceeding upstream, on becoming aware that a vessel proceeding downstream is about to enter a narrow channel, shall stop below the channel until the vessel proceeding downstream has passed through it;

- (ii) When a convoy proceeding upstream has already entered a narrow channel, vessels proceeding downstream shall, so far as possible, stop above the channel until the convoy has passed through it; the same requirement shall apply to single vessels proceeding downstream with respect to a single vessel proceeding upstream;
- (d) On waterways for which “downstream” and “upstream” are not defined:
 - (i) Vessels having no obstacle to starboard and those which in a curved narrow channel have the outside of the curve to starboard shall hold their course and other vessels shall wait until they have passed through the narrow channel; however, this provision shall not apply between small craft and other vessels;
 - (ii) In the case of a meeting between a small craft under sail and a small craft of another category, the small craft under sail shall maintain its course and the other shall wait until the small craft under sail has passed through the narrow channel;
 - (iii) In the case of two sailing vessels meeting, the vessel to windward or, if both are navigating with the wind, the vessel which has the wind on the starboard side shall maintain its course and the other vessel shall wait until it has passed through the narrow channel.

This provision does not apply to small sailing craft in relation to other vessels.

2. When a meeting in a narrow channel has become inevitable, the vessels concerned shall take every possible precaution to ensure that they pass at a point and under conditions involving the minimum danger. A boatmaster seeing any danger of collision shall sound a series of very short blasts.

Article 6.08 - Meeting prohibited by waterway signs

- 1. On approaching a section marked with the prohibitory sign A.4 (annex 7),
 - (a) On waterways for which “downstream” and “upstream” are defined,
 - Vessels proceeding upstream shall stop at the approach of vessels proceeding downstream and wait until they have passed through the section;
 - (b) On waterways for which “downstream” and “upstream” are not defined,
 - The corresponding rules in article 6.07 apply.
- 2. If, in order to prevent any meeting, the competent authorities prescribe alternate one-way traffic:
 - Prohibition of passage shall be indicated by a general prohibitory sign (A.1, annex 7);

- Authorization of passage shall be indicated by a general “entry permitted” sign (E.1, annex 7).

Depending on local circumstances, warning of the sign prohibiting passage may be given by the mandatory sign B.8 (annex 7) used as an advance sign.

3. If the signs referred to in paragraph 2 above cannot be displayed, vessels shall stop and wait until authorization to proceed is given by representatives of the competent authorities.¹

Article 6.09 - Overtaking: General provisions

1. Overtaking is permitted only if the overtaking vessel has made certain that it can be accomplished without danger.
2. The vessel being overtaken shall facilitate overtaking insofar as it is necessary and possible. It shall slow down, if necessary, to permit overtaking to be accomplished without danger and quickly enough not to hamper the movements of other vessels.

This provision shall not apply to a small craft overtaking a vessel of another category.

Article 6.10 - Overtaking

1. As a general rule, the overtaking vessel shall pass to port of the vessel being overtaken. Where the channel is unquestionably wide enough, the overtaking vessel may also overtake to starboard of the vessel being overtaken.
2. In the case of two sailing vessels, the overtaking vessel shall as a general rule pass on the side on which the vessel being overtaken has the wind. This provision shall not apply to a small sailing craft which is overtaken by another sailing vessel.

When a vessel is being overtaken by a sailing vessel, it shall facilitate overtaking on the side on which the overtaking craft has the wind. This provision shall not apply to a small sailing craft overtaking another vessel.

3. If overtaking is possible without the vessel being overtaken changing its course or speed, the overtaking vessel need give no sound signal.
4. When overtaking is impossible without the vessel being overtaken changing course, or when it appears that the vessel being overtaken may not have noticed the intention to overtake and that this may cause a danger of collision, the overtaking vessel shall sound:
 - (a) Two long blasts followed by two short blasts if it wishes to pass to port;
 - (b) Two long blasts followed by one short blast if it wishes to pass to starboard.

¹ The competent authorities may waive this provision.

5. If the vessel being overtaken can grant this request by the overtaking vessel, it shall leave the necessary space on the side requested, moving over towards the other side if necessary, and sound:

- (a) One short blast when it is to be overtaken to port;
- (b) Two short blasts when it is to be overtaken to starboard.¹

6. When overtaking is not possible on the side requested by the overtaking vessel, but possible on the other side, the vessel being overtaken shall sound:

- (a) One short blast when overtaking is possible to port;
- (b) Two short blasts when overtaking is possible to starboard.

If the overtaking vessel still wishes to pass, it shall then sound two short blasts in case (a) or one short blast in case (b).

The vessel being overtaken shall then leave the necessary space on the side on which it is to be overtaken, moving over to the other side if necessary.

7. When overtaking is impossible without danger of a collision, the vessel being overtaken shall sound five short blasts.

8. Paragraphs 4 to 7 above shall not apply to small craft in relation to other vessels or to small craft overtaking other small craft.

Article 6.11 - Overtaking prohibited by waterway signs

Without prejudice to the provisions of article 6.08, paragraph 1, overtaking is prohibited:

- (a) Generally on sections marked by the sign A.2 (annex 7);
- (b) Between convoys in the areas marked by the sign A.3 (annex 7). However, this prohibition shall not apply when at least one of the convoys is a pushed convoy whose maximum dimensions do not exceed 110 m by 12 m.

C. OTHER RULES OF THE ROAD

Article 6.12 - Navigation on sections where the course is prescribed²

1. On sections where the course to be followed is prescribed, that course shall be marked by the mandatory signs B.1, B.2, B.3 or B.4 (annex 7). The end of the section may be indicated by the informative sign E.11 (annex 7).

¹ The competent authorities may decide not to prescribe these signals.

² The competent authorities may decide to waive the provisions of this article or to retain only paragraph 1.

2. On such a section, vessels proceeding upstream shall in no case impede the progress of those proceeding downstream; in particular, on approaching the mandatory sign B.4, they shall if necessary reduce speed or even stop to allow vessels proceeding downstream to manoeuvre.

Article 6.13 - Turning

1. Vessels may turn only after making certain that the movements of other vessels will allow them to do so safely, and without obliging such other vessels to change their course or speed abruptly.

2. If the intended manoeuvre will oblige other vessels to change their course or speed, the vessel wishing to turn shall, before turning, announce its intention in good time by sounding:

(a) A long blast followed by a short blast if it wishes to turn to starboard; or

(b) A long blast followed by two short blasts if it wishes to turn to port.

3. The other vessels shall, so far as is necessary and possible, change their speed and course to allow the turn to be made safely. In particular, when vessels wish to turn in order to head against the current, the other vessels shall help to ensure that they can do so in good time.

4. The provisions of paragraphs 1 to 3 above shall not apply to small craft in relation to other vessels. For small craft among themselves, only paragraphs 1 and 3 shall apply.

5. All turning is prohibited on sections marked with the prohibitory sign A.8 (annex 7). On the other hand, if sections of a waterway are marked with the informative sign E.8 (annex 7), boatmasters are recommended to choose such sections for turning, to which manoeuvre the provisions of this article remain applicable.

Article 6.14 - Procedure on departure

The provisions of article 6.13 above shall apply also to vessels, other than ferry-boats, when leaving their anchorage or berth without turning; however, the signals prescribed in paragraph 2 of that article shall be replaced by the following:

One short blast when the vessels are approaching on the starboard side;

Two short blasts when they are approaching on the port side.

Article 6.15 - Prohibition of entering the spaces between vessels in a towed convoy

Entering the spaces between vessels in a towed convoy is prohibited.

*Article 6.16 - Harbours and tributary waterways: entering and leaving;
leaving followed by crossing the waterway*

1. Vessels may enter or leave a harbour or a tributary waterway or enter or cross the waterway only after making certain that they can do so safely and without obliging other vessels to change their course or speed abruptly.

If a vessel proceeding downstream is obliged to turn upstream in order to enter a harbour or tributary waterway, it shall accord priority to any vessel proceeding upstream which also wishes to enter the harbour or tributary waterway.

In certain cases, waterways considered to be tributaries may be marked by one of the signs E.9 or E.10 (annex 7).

2. If the intended manoeuvre is likely or certain to oblige other vessels to change their course or speed, vessels carrying out any of the manoeuvres referred to in paragraph 1 above shall announce the manoeuvre by sounding in good time:

- Three long blasts followed by one short blast when, to enter or after leaving, they have to turn to starboard;
- Three long blasts followed by two short blasts when, to enter or after leaving, they have to turn to port;
- Three long blasts when, after leaving, they wish to cross the waterway.

Before completing the crossing, they shall, if necessary, sound:

- One long blast followed by one short blast if they wish to turn to starboard, or
- One long blast followed by two short blasts if they wish to turn to port.

3. The other vessels shall change their course and speed if necessary.

This provision shall also apply when the sign B.10 (annex 7) is placed on the main waterway near the exit from a harbour or tributary waterway.

4. If the sign B.9 (a) or B.9 (b) (annex 7) is placed near the exit from a harbour or tributary waterway, vessels leaving that harbour or waterway may enter or cross the main waterway only if their doing so will not oblige vessels proceeding on it to change their course or speed.

5. Vessels may not enter a harbour or tributary waterway when the sign A.1, together with the additional sign shown in annex 7, section II, paragraph 2, is displayed on the main waterway.

Vessels may not leave a harbour or tributary waterway when the sign A.1, together with the additional sign shown in annex 7, section II, paragraph 2, is near the exit.

6. If the sign E.1 together with the additional sign shown in annex 7, section II, paragraph 2, is displayed on the main waterway, vessels may enter a harbour or tributary waterway even if their doing so might oblige vessels proceeding on the main waterway to change their course or speed. Vessels may leave if the sign E.1, together with the additional sign shown in annex 7, section II, paragraph 2, is displayed near the exit; in this case, the sign B.10 (annex 7) shall be displayed on the main waterway.

7. The provisions of paragraphs 1 to 3 shall not apply to small craft in relation to other vessels, nor shall those of paragraph 4 apply to vessels which are not small craft in relation to small craft. The provisions of paragraph 2 shall not apply to small craft among themselves.

Article 6.17 - Sailing abreast

1. Vessels may sail abreast only if there is enough room to do so without inconvenience or danger to shipping.

2. Except when overtaking or passing, it is prohibited to sail within 50 m of a vessel, side-by-side formation or pushed convoy showing the marking referred to in article 3.14, paragraphs 2 or 3.

3. Without prejudice to the provisions of article 1.20, it is prohibited to go alongside a vessel or an assembly of floating material under way, to grapple it or to ride along in its wake, without the express permission of its boatmaster.

4. Water skiers and persons practising aquatic sports without the use of a vessel shall keep at a sufficient distance from vessels and assemblies of floating material under way and from floating equipment at work.

Article 6.18 - Prohibition of trailing of anchors, cables or chains

1. The trailing of anchors, cables or chains is prohibited.

2. This prohibition shall not apply to small movements at stopping places or to manoeuvring; it shall, however, apply to movements and manoeuvring on sections marked, in accordance with article 7.03, paragraph 1 (b), with the prohibitory sign A.6 (annex 7).

3. This prohibition shall not apply either on sections marked, in accordance with article 7.03, paragraph 2, with the informative sign E.6 (annex 7).

Article 6.19 - Drifting

1. Drifting is prohibited. This prohibition shall not apply to small movements at places of stopping, loading or unloading.
2. Vessels drifting downstream while facing upstream with engines running “ahead” are considered to be going upstream, not drifting.

Article 6.20 - Wash

1. Vessels shall regulate their speed to avoid creating excessive wash or suction likely to cause damage to stationary or moving vessels or structures. In particular, they shall reduce speed in good time, but not to below the speed required to steer safely:
 - (a) Outside harbour entrances;
 - (b) Near vessels made fast to the bank or to a landing-stage, or loading or discharging cargo;
 - (c) Near vessels lying at normal stopping places;
 - (d) Near ferry-boats which are not moving independently;
 - (e) On sections of the waterway designated by the competent authorities; such sections may be marked by the sign A.9 (annex 7).
2. Subject to the provisions of article 1.04, vessels are not required to fulfil the obligations imposed by paragraph 1 (b) and (c) above in respect of small craft.
3. When passing vessels displaying the signals prescribed in article 3.25, paragraph 1 (c), or vessels, assemblies of floating material or floating establishments displaying the signals prescribed in article 3.29, paragraph 1, other vessels shall reduce speed as prescribed in paragraph 1 above. They shall also keep as far off as possible.

Article 6.21 - Convoys

1. Motorized vessels propelling a convoy shall have sufficient power to ensure proper control of the convoy.
2. The pusher of a pushed convoy shall be capable without turning or stopping the convoy in good time in such a way that the convoy remains under proper control.¹

¹ The competent authorities may, depending on navigating conditions on the waterway concerned, exempt pushed convoys under a certain length from this obligation and extend the obligation to single motorized vessels over a certain length.

3. It is prohibited for motorized vessels towing or pushing other vessels or propelling them in side-by-side formation to leave them during making-fast or anchoring operations before the navigable channel has been cleared of such vessels and the boatmaster of the convoy has satisfied himself that they are in a secure position.

4. Ship-borne barges shall not be placed at the head of a pushed convoy unless anchors may be presented at the head of the convoy.

Article 6.21 bis - Relocation of pushed barges outside a pushed convoy

Outside a pushed convoy, a pushed barge, may only be moved:

- (a) Being coupled side-by-side to a motorized vessel;
- (b) On short distances when a pushed convoy is being formed or broken up.

Article 6.22 - Suspension of navigation

When the competent authorities announce by the general prohibitory sign A.1 (annex 7) that navigation is suspended, all vessels shall stop short of that sign.

Article 6.22 bis - Navigation when passing floating equipment at work or grounded or sunken vessels, and vessels whose ability to manoeuvre is limited

It is prohibited to pass the vessels referred to in article 3.25 on the side on which they show the red light or lights prescribed in article 3.25 (b) and (d), or the board bearing the sign A.1 (annex 7), the red ball or the red flag prescribed in article 3.25, paragraph 1 (b) and (d), or to pass the vessels referred to in article 3.34 on the side on which they show the two red lights or the two black balls prescribed in article 3.34, paragraph 2 (a).

D. FERRY-BOATS

Article 6.23 - Rules applicable to ferry-boats

1. Ferry-boats may cross the waterway only after making certain that the movement of other vessels enables them to do so without risk and that the latter are not obliged to change their course or speed abruptly.¹

2. A ferry-boat which is not moving independently shall, in addition, comply with the following rules:

(a) When not operating, it shall lie at the berth assigned to it by the competent authority. If no berth has been assigned to it, it shall lie in such a position that the channel remains clear;

¹ The competent authorities may prescribe that this provision does not apply to ferry-boats not moving independently in their relation to small craft.

(b) When the longitudinal cable of a ferry-boat may block the navigable channel, the ferry-boat may stop on the side of the channel opposite the point at which the cable is made fast only as long as is strictly necessary for embarking and disembarking. During these operations, approaching vessels may request the clearing of the channel by sounding one long blast in good time;

(c) A ferry-boat shall not remain in the channel longer than is necessary for the service it provides.

E. PASSAGE UNDER BRIDGES AND THROUGH WEIRS AND LOCKS

Article 6.24 - Passage under bridges and through weirs: General

1. At the opening of a bridge or weir, the rules of article 6.07 shall apply unless the channel is wide enough for simultaneous passage.

2. When passage through the opening of a bridge or weir is authorized and the opening is marked by:

(a) The sign A.10 (annex 7),

navigation is prohibited outside the area between the two boards constituting this sign;

(b) The sign D.2 (annex 7),

vessels are recommended to keep within the area between the two boards or lights constituting this sign.

Article 6.25 - Passage under fixed bridges

1. When certain openings of fixed bridges are marked by:

one or more red lights or red-white-red boards (sign A.1, annex 7), such bays are prohibited to shipping.

2. When certain openings of fixed bridges are marked by:

(a) The sign D.1 (a) (annex 7), or

(b) The sign D.1 (b) (annex 7),

placed above the opening,

it is recommended that these openings should be given preference.

If the channel is marked with the sign referred to in (a) above, it is open to shipping in either direction.

If it is marked with the sign referred to in (b) above, it is closed to shipping coming from the other direction.

3. When certain openings of fixed bridges are marked as specified in paragraph 2 above, vessels may use the unmarked openings only at their own risk.

Article 6.26 - Passage under movable bridges

1. Without prejudice to the other provisions of these regulations and to any other provisions applicable, boatmasters shall, on approaching and passing under movable bridges, obey any instructions given them by the bridge staff to ensure safe and orderly navigation or quick passage.

2. On approaching a movable bridge, vessels shall reduce speed.

If they cannot or do not wish to pass under the bridge, and if boards bearing the sign B.5 (annex 7) are placed on the bank, they shall stop short of those boards.

3. Overtaking when approaching movable bridges is prohibited unless special instructions are given by the bridge staff.

4. Passage under movable bridges may be regulated by the following signals:

(a) One or more red lights mean:

Passage prohibited;

(b) A red light and a green light at the same height or a red light above a green light mean:

Passage is still prohibited, but the bridge is being opened and vessels should prepare to get under way;

(c) One or more green lights mean:

Passage permitted;

(d) Two red lights one above the other mean:

The opening of the bridge for shipping is suspended;

(e) A yellow light placed on the bridge together with the marking referred to under (a) and (d) above means:

Passage prohibited except for vessels of reduced height; passage authorized in both directions;

(f) Two yellow lights placed on the bridge together with the marking referred to under (a) and (d) above mean:

Passage prohibited except for vessels of reduced height; passage prohibited in the other direction.

5. The red lights referred to in paragraph 4 above may be replaced by red-white-red boards (sign A.1, annex 7), the green lights by green-white-green boards (sign E.1, annex 7) and the yellow lights by yellow boards (sign D.1, annex 7).

Article 6.27 - Passage through weirs

1. The trailing of anchors, cables or chains at or near a weir is prohibited.

2. Passage through an opening in a weir is permitted only when the opening is marked to the left and to the right by:

A sign E.1 (annex 7).

3. Prohibition of passage through an opening in a weir may be indicated by:

One or more red lights or red-white-red boards (sign A.1, annex 7).

4. By derogation from paragraph 2 above, in the case of weirs with an overhead bridge, passage through an opening may also be authorized by:

A sign D.1 (annex 7) placed on the bridge above the channel.

Article 6.28 - Passage through locks

1. Vessels approaching lock basins shall reduce speed. If they cannot or do not wish to enter the lock immediately, and if a board bearing the sign B.5 (annex 7) is placed on the bank, they shall stop short of that board.

2. In lock basins and locks, vessels equipped with a radiotelephone permitting communication on the nautical information network shall listen on the channel allotted to the lock.

3. Passage through locks shall be in the order of arrival in the lock basins. Small craft shall not be entitled to demand separate locking. They shall not enter the lock until invited to do so by the lock staff. Furthermore, when small craft are passing through at the same time as other vessels, they shall enter the lock only after the latter.

4. Overtaking in or near locks, and especially in lock basins, is prohibited.

5. In locks, anchors shall be in the fully raised position; the same shall apply in lock basins, unless the anchors are in use.

6. On entering locks, vessels shall reduce speed so as to avoid bumping against the gates or protective devices or against other vessels, assemblies of floating material or floating establishments.

7. In locks:
- (a) If limits are marked on the side-walls, vessels shall keep within those limits;
 - (b) While the lock is being filled or emptied and until they are allowed to leave, vessels shall be made fast and the mooring ropes shall be so handled as to prevent bumping against the walls, gates or protective devices or against other vessels or assemblies of floating material;
 - (c) The use of fenders, which shall be floating fenders if movable, shall be compulsory;
 - (d) It is prohibited for vessels and assemblies of floating material to discharge or run off water onto the copings or onto other vessels or assemblies of floating material;
 - (e) The use of mechanical means of propulsion is prohibited from the time the vessel is made fast until it is allowed to leave;¹
 - (f) Small craft shall keep away from other vessels.

8. In locks and lock basins it is obligatory to keep a minimum lateral distance of 10 m from the vessels or convoys carrying the blue light or the blue cone referred to in article 3.14, paragraph 1. However, this obligation shall not apply to vessels and convoys also showing this marking nor to the vessels referred to in article 3.14, paragraph 7.

9. Vessels and convoys showing the marking referred to in article 3.14, paragraphs 2 or 3, shall be locked separately.

10. Vessels and convoys showing the marking referred to in article 3.14, paragraph 1 shall not be locked with passenger vessels.

11. In order to ensure safe and orderly navigation, quick passage through locks or their full use, the lock staff may give instructions supplementing or departing from the provisions of this article. Vessels in locks and lock basins shall comply with such instructions.

Article 6.28 bis - Entering and leaving locks

1. Admittance to a lock shall be regulated both by day and by night by visual signals (marking) placed on one side or on both sides of the lock. Such signals shall have the following meaning:

- (a) Two red lights one above the other:
No entry, lock out of service;

¹ The competent authorities may waive this provision.

- (b) A single red light or two red lights side by side:

No entry, lock closed;

- (c) Extinction of one of the two red lights side by side or one red light and one green light side by side or a red light above a green light:

No entry, lock being prepared for opening;

- (d) A single green light or two green lights side by side:

Entry permitted.

2. Exit from a lock shall be regulated both by day and by night by the following visual signals (marking):

- (a) One or two red lights: No exit;

- (b) One or two green lights: Exit permitted.

3. The red light or lights referred to in paragraphs 1 and 2 above may be replaced by a board bearing the sign A.1 (annex 7).

The green light or lights referred to in the same paragraphs may be replaced by a board bearing the sign E.1 (annex 7).

4. In the absence of lights and boards, it is prohibited to enter or leave locks except by express order of the lock staff.

Article 6.29 - Priority of passage through locks

By derogation from article 6.28, paragraph 3, the following shall have priority of passage through locks:

- (a) Vessels belonging to the competent authority or to the fire, police or customs services under way on urgent duty;

- (b) Vessels to which the competent authority has expressly granted priority, and carrying the red pennant prescribed in article 3.17.

When these vessels approach lock basins or are made fast in them, other vessels shall facilitate as much as possible passage by such vessels.

F. REDUCED VISIBILITY - NAVIGATION BY RADAR

Article 6.30 - General rules for navigation in reduced visibility

1. Vessels under way in reduced visibility shall adjust their speed as required by these conditions and the presence and movements of other vessels and local circumstances.¹ They shall be equipped with a radiotelephone for vessel-to-vessel and vessel-to-shore communication in good working order and meeting the requirements of the competent authorities concerned.² They shall post a look-out at the bow.³ In the case of convoys, however, a look-out is required on the leading vessel only. The look-out shall be within sight or hearing of, or in communication through a voice link with the boatmaster of the vessel or convoy. Vessels shall give the sound signals prescribed in articles 6.32 and 6.33 below and carry the lights prescribed for the night marking of vessels under way.
2. Vessels shall stop as soon as, by reason of reduced visibility, the presence and movements of other vessels and local conditions, they can no longer proceed without danger. In addition, when, in a towed convoy, visual communication is no longer possible between the towed vessels and the motorized vessel leading the convoy, the convoy shall stop at the nearest suitable place.
3. In deciding whether to stop or to proceed and in order to determine their speed, vessels using radar may take into account radar observations. They shall, however, take into account the reduced visibility for other vessels.
4. When stopping, vessels shall as far as possible keep clear of the channel.
5. When under way in reduced visibility, vessels equipped with a radiotelephone for the vessel-to-vessel network shall listen on the channel indicated by the competent authority and give other vessels any information needed for safe navigation.
6. Vessels proceeding on their course shall when meeting another vessel keep to the right as far as is necessary to allow passing port to port. The provisions of articles 6.04, paragraphs 3, 4 and 5 (Class I) and of article 6.05 shall not apply in reduced visibility.⁴

¹ The competent authority may also prohibit towed convoys proceeding downstream in reduced visibility on particular sections with a current.

² The competent authorities may decide not to prescribe such a radiotelephone.

³ The competent authorities may, depending on navigating conditions on the waterway concerned, waive the look-out for a ferry-boat not moving independently.

⁴ The competent authorities may waive this provision or apply it only on certain waterways.

Article 6.31 - Sound signals when stationary

CLASS I

1. In reduced visibility, vessels and floating equipment stationary in or near the channel outside harbours or places specially designated by the competent authorities for berthing shall, as soon and as long as they hear from an approaching vessel one of the signals prescribed in article 6.32, paragraphs 4 (a) and 5 (a) or article 6.33, paragraph 2, give signals as follows:

(a) When they are to the left of the channel (for an observer facing downstream):¹

One peal of a bell;

(b) When they are to the right of the channel (for an observer facing downstream):²

Two peals of a bell;

(c) When their position is uncertain:

Three peals of a bell.

2. These signals shall be repeated at intervals of not more than one minute.

3. The provisions of paragraphs 1 and 2 above shall not apply to vessels in a pushed convoy other than the pusher. In the case of a side-by-side formation, they shall apply only to one vessel in the formation. In the case of a towed convoy, they shall apply only to the towing vessel and the last vessel in the convoy.

CLASS II

1. Vessels berthed in or near the channel outside harbours or places specially designated by the competent authorities for berthing shall, as soon and as long as they hear from an approaching vessel one of the signals prescribed in articles 6.32 and 6.33, give:

One peal of a bell.

However, vessels not parallel to the side of the channel, or positioned in such a way that they may be a danger to other vessels, shall give this signal even without hearing any of the signals referred to above.

4. The vessels referred to in paragraph 1, when stationary on certain waterways indicated by the competent authorities, may, instead of the signal prescribed in paragraph 1, sound:

One long blast between two short blasts.

¹ The competent authority may prescribe the signals provided for in (a) and (b) only by day.

² *Idem.*

5. This article shall also apply to vessels grounded in or near the channel which may present a danger to other vessels.

Article 6.32 - Provisions for vessels navigating by radar

1. A vessel is considered to be navigating by radar when, in conditions of reduced visibility, it navigates using the following equipment:

(a) A radar set and a device indicating the changes in the vessel's direction, in good working order and meeting the requirements of the competent authorities concerned;¹

(b) A radiotelephone providing vessel-to-vessel and vessel-to-shore communication,² as referred to in article 6.30, paragraph 1, in good working order and meeting the requirements of the competent authorities concerned;

(c) A device for emitting the three-tone signal (article 1.01 (w)).¹

2. When a vessel is navigating by radar there shall at all times be one person fully conversant with navigation by radar³ and a second person sufficiently conversant with this method of navigation³ in the wheelhouse.⁴ However, if the wheelhouse is equipped with a centralized control post⁵ it is sufficient that the second person can, if necessary, be summoned to the wheelhouse immediately.

3. Vessels navigating by radar shall be exempt from the obligation to post a look-out as prescribed in article 6.30, paragraph 1 if the boatmaster is able to hear the sound signals.

¹ The competent authorities may permit the use of other radar sets and other means indicating the turning speed of the vessel in place of the equipment prescribed in this paragraph and they may dispense from the use of the latter devices ferry-boats not moving independently. They may also on certain waterways, on certain sections or for small craft permit the use of radar in the absence of the sound signal prescribed in paragraph 1 (c).

² The competent authorities may prescribe a radiotelephone only for the vessel-to-vessel network.

³ The competent authorities may lay down requirements concerning these qualifications.

⁴ The competent authorities may, depending on navigating conditions on the waterway concerned, waive the look-out for a ferry-boat not moving independently.

⁵ As defined in the Recommendations on Technical Requirements for Inland Navigation Vessels (TRANS/SC.3/104), chapter 11.

CLASS I

4. A vessel proceeding downstream and navigating by radar shall, as soon as it sees on the radar screen vessels whose position or movements might cause a dangerous situation, or when it is approaching a section where there might be vessels not yet visible on the screen:

(a) Give the three-tone signal and repeat it as often as necessary; this provision does not apply to small craft;

(b) Reduce speed and, if necessary, stop.

5. A vessel proceeding upstream and navigating by radar shall, as soon as it hears the signals referred to in paragraph 4 (a) above or observes on the screen vessels whose position or movements might cause a dangerous situation, or when it is approaching a section where there might be vessels not yet visible on the screen:

(a) Give one long blast or, in the case of a convoy¹ two long blasts, and communicate by radiotelephone to the vessels proceeding downstream its category, name, position, direction and the side on which it is proposed to pass;

(b) Reduce speed and, if necessary, stop.

CLASS II

4. Vessels navigating by radar, shall, as soon as they see on the radar screen vessels whose position or movements may cause a dangerous situation, or when they are approaching a section where there may be vessels not yet visible on the screen:

(a) Sound one long blast; this signal shall be repeated as often as necessary;

(b) Give oncoming vessels, by radiotelephone, the information necessary for safe navigation;

(c) Reduce speed and, if necessary, stop.

5. Vessels equipped with a radiotelephone and receiving the information referred to in paragraph 4 shall reply by radiotelephone with the necessary information.

Small craft giving the information prescribed in paragraph 4 above shall, in addition, state their category and the side on which they are giving way.

Ferry-boats when complying with the requirements of paragraph 4 shall sound one long blast followed by four short blasts instead of one long blast and shall, in addition, state their category and the course they are taking in crossing the waterway.

¹ The competent authority may prescribe only one long blast for a vessel having on board the boatmaster of a convoy.

6. Vessels proceeding downstream and navigating by radar shall reply by radiotelephone to the vessels proceeding upstream and communicate their category, name, position and direction, and either confirm the side on which it is proposed to pass or indicate another side. However, a small craft shall give its category, name, position, direction and the side on which it is giving way.

7. Overtaking by vessels navigating by radar shall be permitted only after the side on which the vessels are to overtake has been agreed by radiotelephone and provided that the width of the channel is sufficient.

8. In the case of convoys, the requirements in paragraphs 2 and 4 to 7 above shall apply only to the vessel having on board the boatmaster of the convoy.

9. Vessels navigating by radar which see on the radar screen vessels whose position or movements may cause a dangerous situation and which do not reply by radiotelephone shall take steps in good time to avoid a collision.

Article 6.33 - Provisions for vessels not navigating by radar

1. In reduced visibility, vessels not navigating by radar shall post a look-out and have a radiotelephone as prescribed in article 6.30.^{1 2}

2. In conditions of navigation in reduced visibility, a vessel proceeding alone shall sound one long blast and a vessel carrying the boatmaster of a convoy shall sound two long blasts;³ these signals shall be repeated at intervals of not more than one minute.

3. Small craft not navigating by radar may give the signal prescribed in paragraph 2 above; this signal may be repeated.

¹ The competent authorities may prescribe that such vessels shall be capable, if necessary, of stopping within a distance not exceeding half the range of visibility.

² The competent authorities may waive the requirement for a radiotelephone.

³ The competent authorities may prescribe only one long blast for a vessel having on board the boatmaster of a convoy.

CLASS I

4. A vessel not navigating by radar in reduced visibility shall, as soon as it hears the three-tone signal referred to in article 6.32, paragraph 4 (a):

(a) If it is near to a bank: keep close to that bank and, if necessary, stop there until the other vessel has passed;

(b) If it is in the channel, and especially if it is crossing from one bank to another: clear the channel as fully and as quickly as possible.

5. Vessels not navigating by radar shall, as soon as they hear from another vessel apparently forward of their beam the fog-signal referred to in paragraph 2 of this article, reduce speed to the minimum at which they can hold their course and navigate with extreme caution or, if necessary, stop or turn.

CLASS II

4. Ferry-boats not navigating by radar shall, instead of the signal prescribed in paragraph 2 above, give as a fog-signal one long blast followed by four short blasts: this signal shall be repeated at intervals of not more than one minute.

G. SPECIAL RULES

Article 6.34 - Special priorities

1. When meeting or crossing the course of:

(a) A vessel showing the marking referred to in article 3.34;

(b) A vessel showing the marking referred to in article 3.35, other vessels shall give way.

2. Where a vessel of the category referred to in paragraph 1 (a) above meets or crosses the course of a vessel of the category referred to in paragraph 1 (b) above, the latter vessel give way to the former.

3. Vessels shall not approach within 1,000 m of the rear of a vessel showing the marking referred to in article 3.37.

Article 6.35 - Water skiing and similar activities

1. Water skiing and similar activities are permitted only by day and in good visibility.¹

¹ The competent authorities shall designate areas where these activities are permitted or prohibited.

2. The boatmaster of the towing vessel shall be accompanied by a person responsible for the tow and for supervision of the skier and competent for those purposes.
3. Except when navigating in a channel reserved for their exclusive use, towing vessels and water skiers shall keep at a sufficient¹ distance from all other vessels, from the bank and from bathers.
4. The tow rope shall not be trailed unheld.

Article 6.36 - Conduct of, and in respect of, fishing vessels

1. Trolling with several vessels abreast is not permitted.²
2. All vessels are prohibited from passing at a short distance behind a vessel engaged in fishing showing the marking prescribed in article 3.35.

Article 6.37 - Conduct of, and in respect of, underwater divers for sport

1. Underwater diving for sport shall be prohibited in areas where navigation might be hindered, particularly:
 - (a) On the normal course of vessels showing the marking referred to in article 3.16;
 - (b) At entrances to harbours;
 - (c) Near berthing areas;
 - (d) In areas reserved for water skiing or similar activities.
2. All vessels shall keep at a sufficient³ distance from a vessel showing the marking referred to in article 3.36.

¹ Distance to be determined by the competent authorities, who may extend this provision to other categories of equipment.

² The competent authorities may decide to waive this provision.

³ Distance to be determined by the competent authorities.

Chapter 7

BERTHING RULES

Article 7.01 - General principles of berthing

1. Without prejudice to the other provisions of these regulations, vessels and assemblies of floating material shall choose their berths as near the bank as their draught and local conditions permit and, in any case, so as not to obstruct shipping.
2. Except under special conditions laid down by the competent authorities, floating establishments shall be so placed as to leave the channel clear for shipping.
3. Vessels, assemblies of vessels and of floating material and floating establishments shall, when stationary, be anchored or made fast in such a way that they cannot change position and thus constitute a danger or obstruction to other vessels taking into account, in particular, the wind, changes in the water level, suction and wash.

Article 7.02 - Berthing

1. Vessels, assemblies of floating material or floating establishments may not berth:
 - (a) In sections of the waterway where berthing is generally prohibited;
 - (b) In sectors designated by the competent authorities;
 - (c) In sectors marked by the sign A.5 (annex 7); the prohibition then applies on the side of the waterway on which the sign is placed;
 - (d) Under bridges and high-voltage electric lines;
 - (e) In or near narrow channels within the meaning of article 6.07 or in or near sectors which would become narrow channels if vessels berthed there;
 - (f) At the entrances to or exits from tributary waterways;
 - (g) On the course of ferry-boats;
 - (h) On the course taken by vessels to come alongside or leave a landing stage;
 - (i) In turning areas marked by the sign E.8 (annex 7);
 - (j) Laterally to a vessel carrying the sign prescribed in article 3.33 within the distance in metres indicated in the white triangle on that sign;
 - (k) On stretches of water marked by the sign A.5.1 (annex 7) whose breadth, measured from the sign, is shown in metres on the sign.

2. In sections where berthing is prohibited under the provisions of paragraph 1 (a) to (d) above, vessels, assemblies of floating material and floating establishments may berth only in berthing areas marked by one of the signs E.5 to E.7 (annex 7) and under the conditions laid down in articles 7.03 to 7.06 below.

Article 7.03 - Anchoring

1. Vessels, assemblies of floating material or floating establishments may not anchor:

(a) In sections of the waterway where anchoring is generally prohibited;

(b) In sectors marked by the sign A.6 (annex 7); the prohibition then applies on the side of the waterway on which the sign is placed.

2. In sections where anchoring is prohibited under the provisions of paragraph 1 (a) above, vessels, assemblies of floating material and floating establishments may anchor only in sectors marked by the sign E.6 (annex 7) and only on the side of the waterway on which the sign is placed.

Article 7.04 - Making fast

1. Vessels, assemblies of floating material or floating establishments may not make fast to the bank:

(a) In sections of the waterway where making fast is generally prohibited;

(b) In sectors marked by a sign A.7 (annex 7); the prohibition then applies on the side of the waterway on which the sign is placed.

2. In sections where making fast to the bank is prohibited under the provisions of paragraph 1 (a) above, vessels, assemblies of floating material and floating establishments may make fast only in sectors marked by the sign E.7 (annex 7) and only on the side of the waterway on which the sign is placed.

3. It is prohibited to use trees, railings, posts, marker stones, pillars, metal steps, handrails, etc., for making fast or warping.

Article 7.05 - Berthing areas

1. In berthing areas marked by the sign E.5 (annex 7), vessels and assemblies of floating material may berth only on the side of the waterway on which the sign is placed.

2. In berthing areas marked by the sign E.5.1 (annex 7), vessels and assemblies of floating material may berth only on the stretch of water whose breadth, measured from the sign, is shown in metres on the sign.

3. In berthing areas marked by the sign E.5.2 (annex 7), vessels and assemblies of floating material may berth only on the stretch of water bounded by the two distances shown in metres on the sign. These distances shall be measured from the sign.

4. In berthing areas marked by the sign E.5.3 (annex 7), vessels and assemblies of floating material may not, on the side of the waterway on which the sign is placed, berth abreast in a number greater than that shown in Roman figures on the sign.

5. In berthing areas, vessels shall, in the absence of instructions to the contrary, berth abreast from the bank outwards, on the side of the waterway on which the sign is placed.

Article 7.06 - Berthing authorized for certain types of vessel

In berths displaying one of the signs E.5.4 to E.5.15 (annex 7), berthing shall be authorized only for the types of vessel for which the sign is valid, and only on the side of the waterway on which the sign is placed.

Article 7.07 - Berthing in the vicinity of vessels, pushed convoys and side-by-side formations carrying out certain transport operations involving dangerous substances

1. The minimum distance to be left between two vessels, pushed convoys or side-by-side formations when berthed shall be:

- (a) 10 m if one of them shows the marking referred to in article 3.14, paragraph 1;
- (b) 50 m if one of them shows the marking referred to in article 3.14, paragraph 2;
- (c) 100 m if one of them shows the marking referred to in article 3.14, paragraph 3.

If the two vessels, pushed convoys or side-by-side formations each carry one or more lights or cones, the higher number of lights or cones indicates the distance to be left clear.

2. The obligation referred to in paragraph 1 (a) above shall not apply to:

- (a) Vessels, pushed convoys and side-by-side formations also carrying this marking;
- (b) Vessels not carrying this marking but issued with a certificate of approval in accordance with marginal 10 282 (Annex B.1) or marginal 210 282 (Annex B.2) of ADN (R), and conforming to the safety requirements applicable to vessels referred to in article 3.14, paragraph 1.

3. The competent authority may make exceptions with regard to berthing in particular cases.

Article 7.08 - Watch and surveillance

1. An efficient watch shall be kept continuously on board vessels lying in the channel and on board vessels berthed and loaded with substances referred to in marginal 10 500 of Annex B.1 and in Appendix 4 (list of substances) of Annex B.2 of ADN, or which, having carried such substances, are not free of dangerous gases. However, the competent authorities may exempt vessels berthed in harbour basins from this requirement.
2. All other berthed vessels, assemblies of floating material and floating installations shall be kept under surveillance by a person capable of acting quickly if the need arises, unless such surveillance is rendered unnecessary by local conditions or is waived by the competent authorities.
3. An efficient watch shall be kept continuously on board berthed vessels compelled to carry one, two or three blue lights under article 3.14 or one, two or three blue cones under article 3.32.¹

¹ The competent authorities may exempt vessels berthed in harbour basins and in certain berthing areas from this requirement.

Chapter 8

COMPLEMENTARY PROVISIONS

Article 8.01 - Reporting requirements

1. Boatmasters of vessels and convoys carrying dangerous goods in accordance with the provisions of ADN shall, prior to entering the sectors, traffic control posts, traffic centres and locks indicated by the competent authority, eventually by B.11 signs (annex 7), report their presence on the indicated radiotelephone channel and communicate the following data:

- (a) category of vessel;
- (b) name of vessel;
- (c) position, direction of navigation (if applicable);
- (d) official number of vessel; for seagoing vessels: IMO number;
- (e) deadweight tonnage (maximum load);
- (f) length and breadth of vessel;
- (g) type, length and breadth of convoy;
- (h) draught (only on special request);
- (i) route;
- (j) loading port;
- (k) unloading port;
- (l) nature and quantity of cargo (for dangerous goods: name of substance and, where appropriate, class and UN number);
- (m) signalization required for the carriage of dangerous goods;
- (n) number of persons on board.

2. The data given in paragraph 1 above, except those in (c) and (h), may be communicated by other services or persons to the competent authority either in writing, or by telephone. In all cases, the boatmaster shall report when his vessel or convoy enters the sector subject to the reporting requirement and when it leaves the sector again.

3. When a vessel's journey is interrupted in the sector subject to the reporting requirement for more than two hours, the boatmaster shall report the beginning and end of the interruption.

4. When the data covered by paragraph 1 above change during the journey through the sector subject to the reporting requirement, the competent authority shall be notified immediately.

Chapter 9

**PREVENTION OF POLLUTION OF WATER AND DISPOSAL
OF WASTE OCCURRING ON BOARD VESSELS**

Article 9.01 - Definitions

For the purposes of this chapter, the terms set out below have the following meaning:

1. Terms concerning waste in general

(a) “waste occurring on board”: substances or articles defined in (b) to (f) below, of which the person in charge disposes or of which he intends or is required to dispose;

(b) “waste resulting from the operation of the vessel”: waste and waste water generated on board as a result of the operation and maintenance of the vessel; it includes oily and greasy waste and other waste occurring during the operation of the vessel;

(c) “oily and greasy waste occurring during the operation of the vessel”: waste oil, bilge water and other oily and greasy waste such as waste grease, used filters, used rags, containers and packagings for such waste;

(d) “waste oil”: used oil or other non-reusable grease from engines, gears and hydraulic equipment;

(e) “bilge water”: oily water from the engine-room bilges, peak, cofferdams or side compartments;

(f) “waste grease”: used grease collected from run-off from greasers, bearings and greasing facilities and other non-reusable grease;

(g) “other waste occurring during the operation of the vessel”: domestic waste water, household refuse, sludge, slops and other special waste as defined in paragraph 3 below;

(h) “cargo-related waste”: waste and waste water occurring on board the vessel and deriving from the cargo; cargo remnants and handling residues as defined in paragraph 2, (b) and (d) below are not included in this category;

(i) “reception facility”: a vessel within the meaning of article 1.01 (a) of CEVNI or a facility on land approved by the competent authorities for the collection of waste occurring on board.

2. Cargo terms

(a) “exclusive transport operations”: successive transport operations during which the same cargo or another cargo the carriage of which does not require the prior cleaning of holds or tanks is carried in the vessel’s hold or cargo tank;

(b) “cargo remnants”: liquid cargo remaining in the cargo tanks or in the pipes after unloading when a stripping system in accordance with the European Provisions concerning the International Carriage of Goods by Inland Waterway (ADN) has not been used, and dry cargo remaining in the holds after unloading before manual or mechanical sweepers or suction facilities are used;

(c) “cargo residues”: liquid cargo which cannot be discharged from tanks or pipes using the stripping system and dry cargo which cannot be removed from the hold by the use of manual or mechanical sweepers or suction facilities;

(d) “handling residues”: cargo which falls on the vessel outside the hold during handling;

(e) “swept hold”: hold from which the cargo has been removed using means of cleaning such as manual or mechanical sweepers, but without the use of suction or washing apparatus and containing only cargo residues;

(f) “stripped tank”: tank from which cargo remnants have been removed using a stripping system in accordance with ADN and containing only cargo residues;

(g) “vacuum-cleaned hold”: a hold from which cargo remnants have been removed using a suction technique and containing considerably fewer cargo residues than a swept hold;

(h) “swilled-out hold or tank”: a hold or tank which following swilling-out is suitable for any category of cargo;

(i) “discharge of remnants”: removal of cargo remnants from the holds and from the tanks and pipes using suitable means (e.g. manual or motorized sweepers, suction facility, stripping system) enabling the standard of “swept” or “vacuumed” clean for the hold or “stripped” clean for the cargo tank to be achieved along with the removal of handling residues, packagings and means of stowage;

(j) “swilling-out”: removal of cargo residues from swept or vacuumed holds using steam or water;

(k) “swilling-out water”: water from the swilling-out of swept or vacuumed holds or stripped tanks; it also includes ballast water or rainwater from these holds or tanks.

3. Terms concerning other types of waste

(a) “domestic waste water”: waste water from galleys, messes, bathrooms and laundries and human waste water;

(b) “household refuse”: on-board organic and inorganic household waste and food remains, which do not, however, contain components of the other types of waste defined in article 9.01 above occurring during the operation of the vessel;

(c) “sludge”: residues occurring on board the vessel during the operation of an on-board sewage plant;

(d) “slops”: mixtures of cargo residues with swilling-out water, rust or mud, whether or not suitable for pumping;

(e) “other special waste”: waste occurring during the operation of the vessel other than oily and greasy waste and other than the waste covered by (a) to (d) above.

Article 9.02 - General obligation to exercise vigilance

The boatmaster, other crew members and other persons on board shall exercise every care required by the circumstances in order to avoid polluting the waterway and to restrict to the maximum the amount of waste occurring on board and to avoid as far as possible any mixing of the various categories of waste.

Article 9.03 - Prohibition on discharging and dumping

1. Vessels shall be prohibited from throwing, discharging or allowing to run into the waterway oily or greasy waste occurring during the operation of the vessel or household refuse, sludge, slops and other special waste.

2. Vessels shall be prohibited from throwing, discharging or allowing to run into the waterway any parts of the cargo or cargo-related waste. Packagings and means of stowage shall also be included.

3. Domestic waste water shall not be discharged or allowed to flow into the waterway except in accordance with the respective national provisions.

4. Swilling-out water from the holds shall not be discharged or allowed to flow into the waterway except in accordance with the respective national provisions.

5. Discharge into the waterway of water separated by approved oil-separator vessels shall be exempted from the prohibition contained in paragraph 1 if the maximum content of residual oil after separation is consistently and without prior dilution in accordance with national requirements.¹

6. In the event of the accidental discharge of waste referred to in paragraphs 1 and 2 above or the threat of such discharge, the boatmaster shall notify the nearest competent authorities without delay indicating as precisely as possible the nature, quantity and position of the discharge. In the event of the accidental discharge of waste referred to in paragraphs 3 and 4 above or the threat of such discharge, the boatmaster shall, in accordance with the respective national requirements, notify the nearest competent authorities without delay, indicating as precisely as possible the nature, quantity and position of the discharge.

¹ The competent authorities may permit on their national waterways other exceptions concerning the discharge into the waterway of separated water.

Article 9.04 - On-board collection and processing of waste

1. The boatmaster shall ensure the separate collection on board of oily and greasy waste occurring during the operation of the vessel and referred to in article 9.03, paragraph 1 above in receptacles provided for the purpose and the collection of bilge-water in the engine-room bilges. The receptacles shall be stored on board in such a way that any leakage of the contents may be noticed in time and easily prevented.
2. It shall be prohibited:
 - (a) to use mobile tanks stored on the deck for the collection of waste oil;
 - (b) to burn waste on board;¹
 - (c) to introduce oil or grease-dissolving or emulsifying cleaning agents into the engine-room bilges except for products which do not make the treatment of bilge water by the reception facilities more difficult.
3. The boatmaster shall ensure the separate collection on board and delivery to a reception facility of the waste referred to in article 9.03, paragraph 1 above, such as household refuse, sludge, slops and other special waste. If possible, household refuse shall be deposited separately according to the following categories: paper, glass, other recyclable materials and other refuse.

Article 9.05 - Pollution prevention register (used-oil log), requirements for delivery to reception facilities

1. All vessels equipped with an engine room in accordance with resolution No. 17, excluding small craft, shall carry on board a valid pollution prevention register (used-oil log) conforming to the model in annex 9.²
2. The pollution prevention register (used-oil log) shall be issued and identified by the competent authorities.
3. The oily and greasy waste occurring during the operation of the vessel and referred to in article 9.04, paragraph 1 above shall be delivered, against a receipt, to the reception facilities at regular intervals, depending on the condition and operation of the vessel. The receipt shall consist of an entry in the pollution prevention register (used-oil log) by the reception facility.

¹ The competent authorities may, under certain conditions, permit exceptions to the prohibition on burning waste on their national waterways.

² The competent authorities may require other vessels, assemblies of floating material and floating equipment on their national waterways to carry a pollution prevention register.

4. The competent authority may prescribe the inclusion of other data in the pollution prevention register (used-oil log), e.g.:

- data concerning disposal (certificate of disposal);
- deposit of swilling-out water from the bilges;
- deposit of domestic waste water;
- deposit of slops, sludge and other special waste.

5. A vessel carrying on board other documents concerning the deposit of waste occurring during the operation of the vessel in accordance with regulations applicable outside the waterways covered by CEVNI shall be able to prove by means of these documents that the deposit of waste has taken place outside the above-mentioned waterways. This proof may also be furnished by the oil record book as provided for by the International Convention for the Prevention of Pollution by Ships (MARPOL 73).

Article 9.06 - Painting and external cleaning of vessels

It shall be prohibited to oil or clean the outside of vessels using products which must not be discharged into the waterway.

Annex 1

**DISTINGUISHING LETTER OR GROUP OF LETTERS
INDICATING COUNTRY OF VESSEL'S HOME PORT
OR PLACE OF REGISTRATION**

AUSTRIA	A	NETHERLANDS	N
BELARUS	BY	NORWAY	NO
BELGIUM	B	POLAND	PL
BULGARIA	BG	PORTUGAL	P
CROATIA	HR	REPUBLIC OF MOLDOVA	MD
CZECH REPUBLIC	CZ	ROMANIA	R
FINLAND	FI	RUSSIAN FEDERATION	RUS
FRANCE	F	SLOVAKIA	SK
GERMANY	D	SWEDEN	SE
HUNGARY	HU	SWITZERLAND	CH
ITALY	I	UKRAINE	UA
LITHUANIA	LT	YUGOSLAVIA	YU
Luxembourg	L		

Annex 2

DRAUGHT SCALES ON INLAND WATERWAY VESSELS

1. Draught scales shall be graduated in units not larger than 1 decimetre, from the light water-line to the maximum draught level, in the form of clearly visible bands painted alternately in two different colours.

The graduation shall be indicated by figures painted beside the scale not more than 5 decimetres apart and at the top of the scale; and the position of the intervals shall be fixed and punched, incised or welded marks.

2. If the vessel bears tonnage scales meeting the requirements of paragraph 1 above, such tonnage scales may serve instead of draught scales.

Annex 3

VISUAL SIGNALS (MARKING) ON VESSELS

1. GENERAL

- 1.1 The sketches which follow relate to the signals (marking) provided for in the articles of chapter 3 of CEVNI, but not to those provided for in, or authorized by, the footnotes.
- 1.2 The sketches are for guidance only; reference should be made to the text of the regulations, which alone is authoritative.

In the case of additional markings which may be prescribed, the sketches illustrate:

- either the additional marking alone; or
- where necessary for clarity, both the basic marking (or one of the possible basic markings) and the additional marking.

Only the additional marking is described below the sketch.

- 1.3 Pushed convoys of maximum dimensions not exceeding 110 m by 12 m are regarded as single motorized vessels (see article 3.01, paragraph 3).
- 1.4 Unless otherwise specified, the meaning of the following terms is that given in article 3.01, paragraph 5:

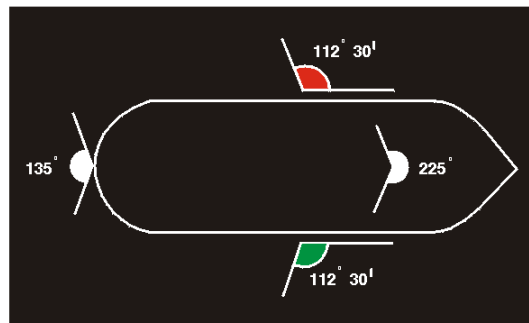

- 1.4.1 "Masthead light": a strong white light, projecting an uninterrupted beam throughout a horizontal arc of 225° and placed so as to project this beam from the bow to $22^\circ 30'$ abaft the beam on each side;
- 1.4.2 "Side lights": a bright green light to starboard and a bright red light to port, each of these lights projecting an uninterrupted beam throughout a horizontal arc of $112^\circ 30'$ and placed so as to project this beam from the bow to $22^\circ 30'$ abaft the beam on each side;
- 1.4.3 "Stern light": an ordinary or bright white light projecting an uninterrupted beam throughout a horizontal arc of 135° and placed so as to project this beam throughout an arc of $67^\circ 30'$ along each side from the stern;
- 1.4.4 "Light visible from all directions": a light projecting an uninterrupted beam throughout a horizontal arc of 360° .

1.5 Explanation of symbols:

a  Fixed light visible from all directions
(a light projecting an uninterrupted beam throughout
a horizontal arc of 360°).

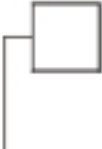
b  Fixed light visible over a limited horizontal arc.
A light which is invisible to the observer is
marked by a dot in the centre.



c  Scintillating light.

d  Optional light.

e  Board or flag (article 3.03).

f  Pennant (article 3.03).

g  Ball (article 3.04).

h  Cylinder (article 3.04).

i  Cone (article 3.04).

j  Bicone (article 3.04).

k  Radar reflector.

NIGHT

SKETCH

DAY

2. MARKING WHEN UNDER WAY

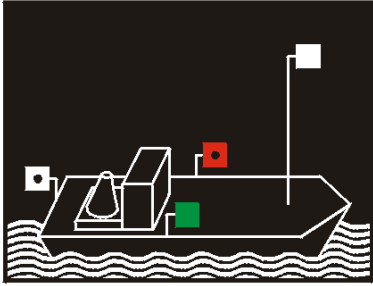
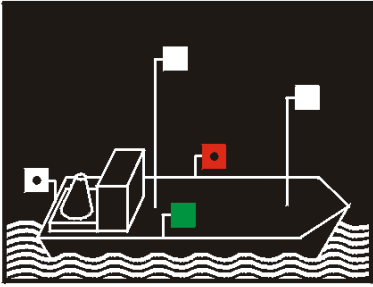
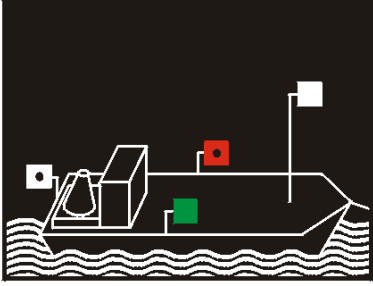
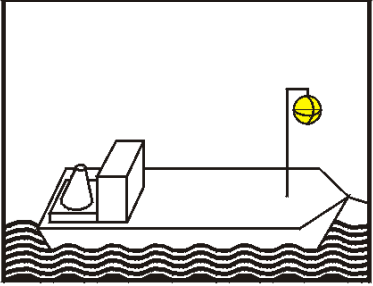
	<p>1</p>	
<p>Article 3.08, paragraph 1: Motorized vessels proceeding alone.</p>		
	<p>2</p>	
<p>Article 3.08, paragraph 2: Motorized vessels proceeding alone with a second masthead light. Compulsory for vessels more than 110 m long.</p>		
	<p>3</p>	
<p>Article 3.08, paragraph 3: Motorized vessel temporarily preceded by an auxiliary motorized vessel.</p>		

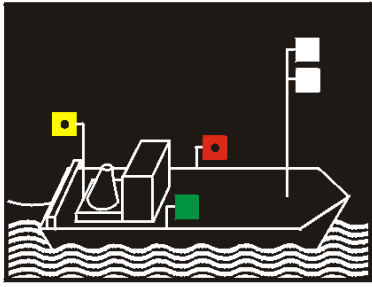
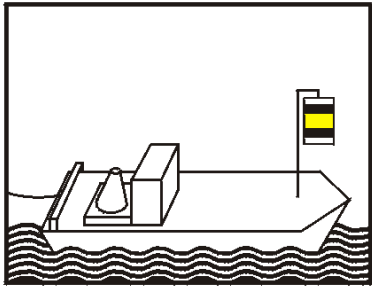
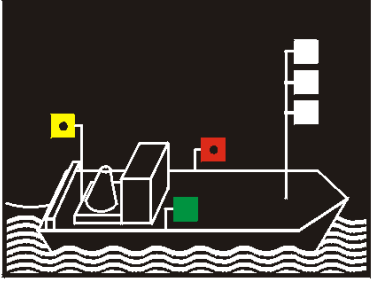
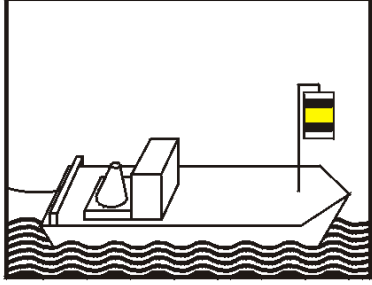
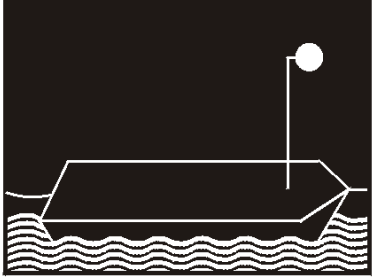
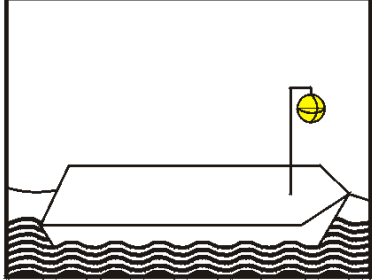
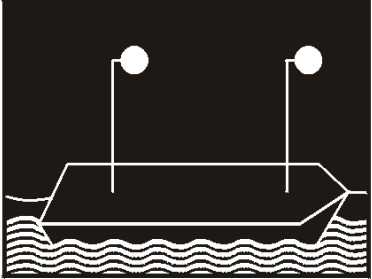
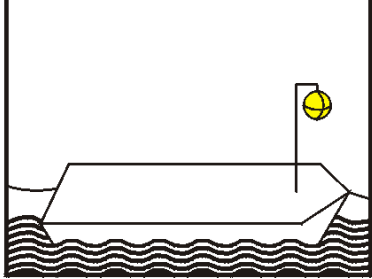
NIGHT	SKETCH	DAY
	4	
Article 3.09, paragraph 1: Motorized vessel leading a towed convoy alone or as an auxiliary.		
	5	
Article 3.09, paragraph 2: Each of several motorized vessels leading a towed convoy or as auxiliaries, when several vessels are proceeding side by side.		
	6	
Article 3.09, paragraph 3: Towed vessels.		
	7	
Article 3.09, paragraph 3, letter a: Section of a towed convoy more than 110 m long.		

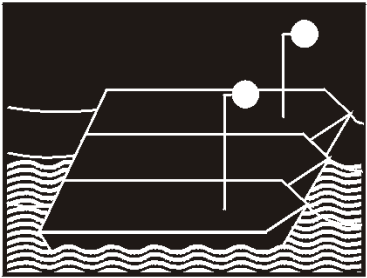
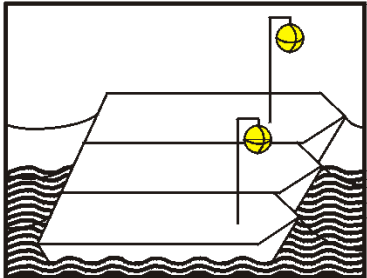
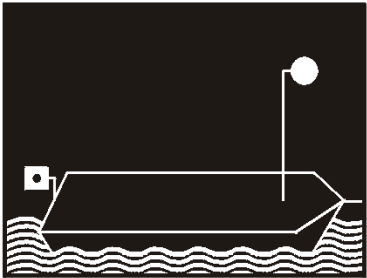
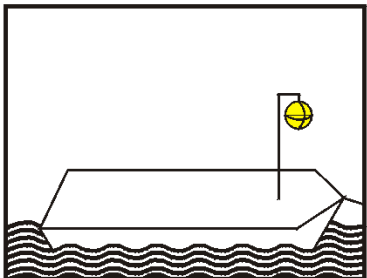
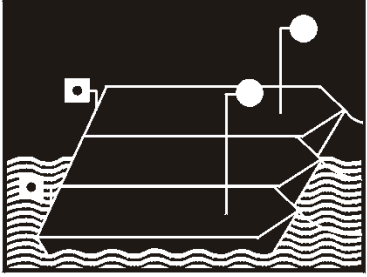
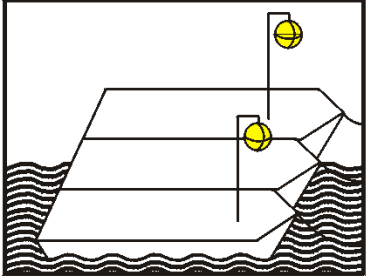
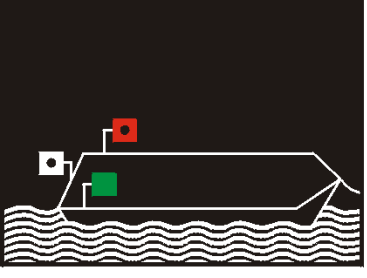
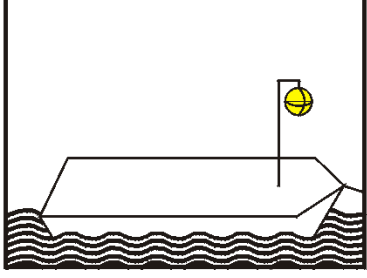

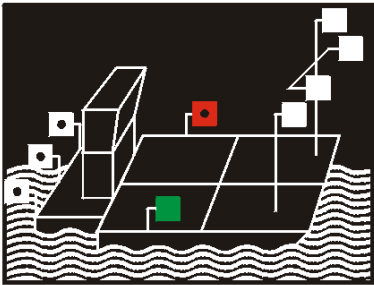
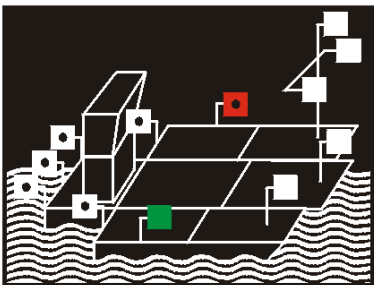
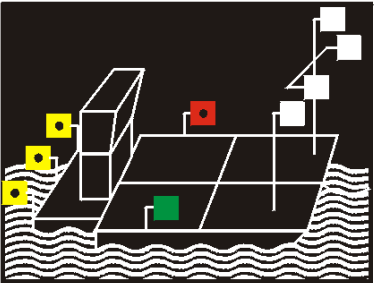
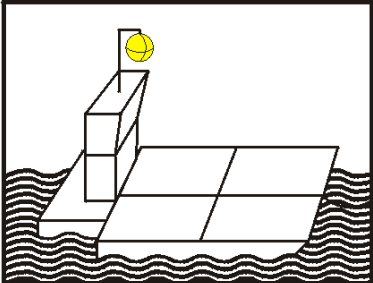
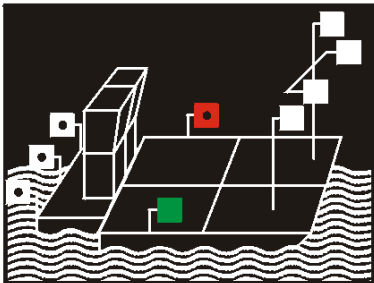
NIGHT	SKETCH	DAY
	8	
<p>Article 3.09, paragraph 3, letter b: Section of a towed convoy comprising a row of more than two vessels coupled side by side.</p>		
	9	
<p>Article 3.09, paragraph 4: Last section of a towed convoy.</p>		
	10	
<p>Article 3.09, paragraph 4: Towed vessels forming the last section of a convoy.</p>		
	11	
<p>Article 3.09, paragraph 6: Towed seagoing vessels coming directly from or leaving for the sea.</p>		

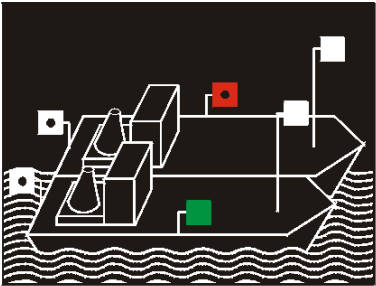
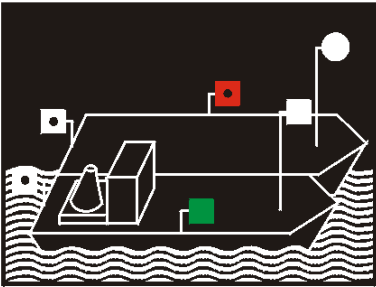
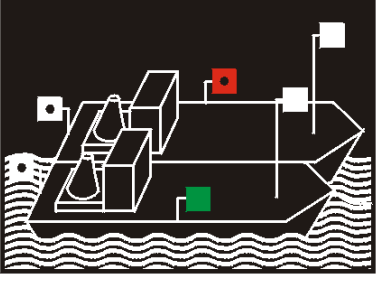
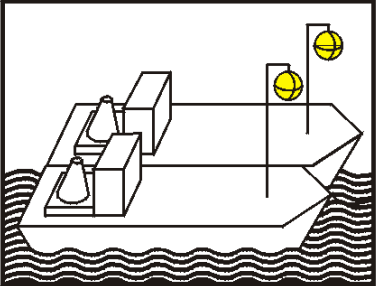
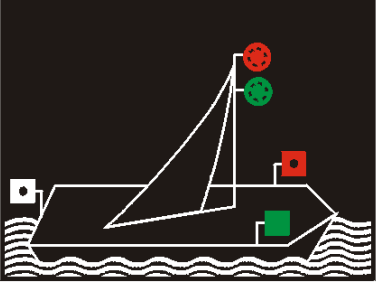
NIGHT	SKETCH	DAY
	12	
<p>Article 3.10, paragraph 1: Pushed convoys.</p>		
	13	
<p>Article 3.10, paragraph 1, letter c.ii: Pushed convoys, when more than two vessels are visible from astern over the full width.</p>		
	14	
<p>Article 3.10, paragraph 2: Pushed convoys preceded by one or more auxiliary motorized vessels.</p>		
	15	
<p>Article 3.10, paragraph 4: Pushed convoys with two pushers.</p>		

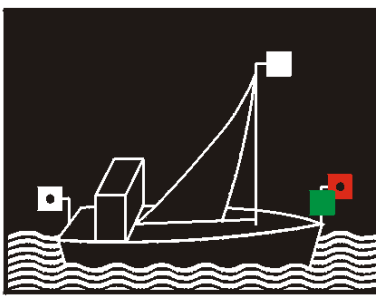
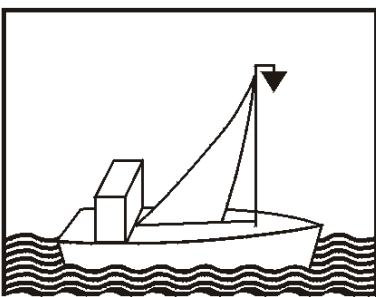
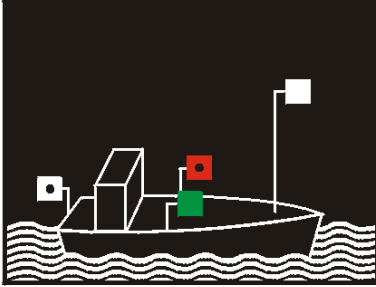
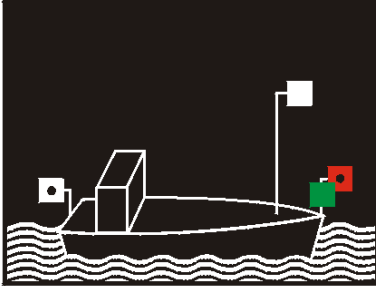
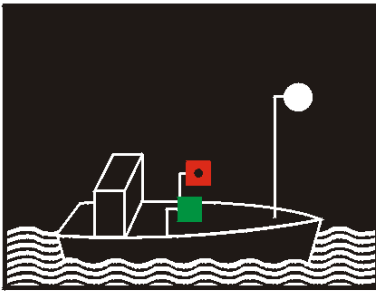
NIGHT	SKETCH	DAY
	16	
<p>Article 3.11, paragraph 1: Side-by-side formations: two motorized vessels.</p>		
	17	
<p>Article 3.11, paragraph 1: Side-by-side formations: one motorized and one non-motorized vessel.</p>		
	18	
<p>Article 3.11, paragraph 2: Side-by-side formations preceded by one or more auxiliary motorized vessels.</p>		
	19	
<p>Article 3.12: Sailing vessels.</p>		

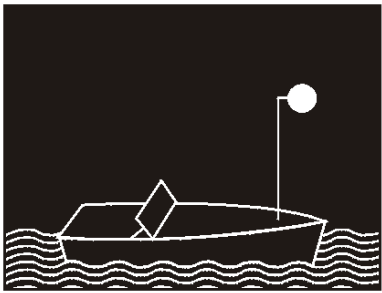
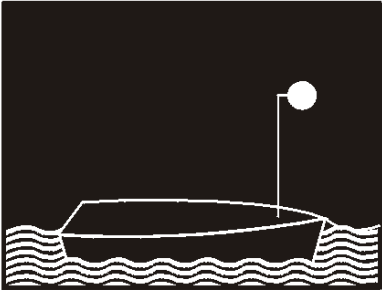
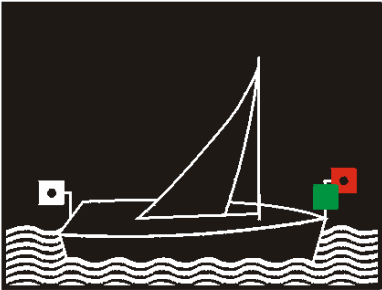
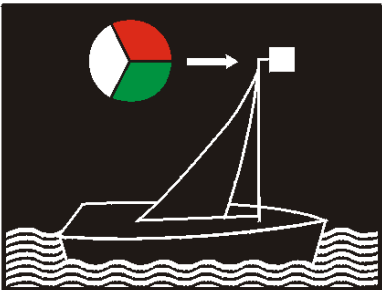
NIGHT	SKETCH	DAY
	20	
<p>Article 3.12, paragraph 3: Vessels proceeding under sail and making use at the same time of its own mechanical means of propulsion.</p>		
	21	
<p>Article 3.13, paragraph 1: Motorized small craft proceeding alone.</p>		
	22	
<p>Article 3.13, paragraph 1: Motorized small craft proceeding alone with side lights side by side or in the same lamp at or near the bow.</p>		
	23	
<p>Article 3.13, paragraph 1: Motorized small craft proceeding alone: the masthead light replaced by a bright white light visible from all directions.</p>		

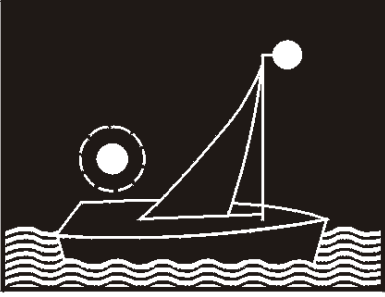
NIGHT	SKETCH	DAY
	24	
<p>Article 3.13, paragraph 2: Motorized small craft less than 7 m long proceeding alone.</p>		
	25	
<p>Article 3.13, paragraph 4: Small craft towed or propelled in side-by-side formation.</p>		
	26	
<p>Article 3.13, paragraph 5: Small sailing craft.</p>		
	27	
<p>Article 3.13, paragraph 5: Small sailing craft, with side lights and a stern light in the same lamp near the top of the mast.</p>		

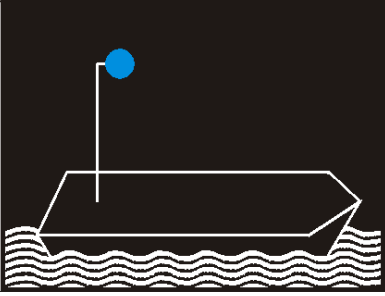
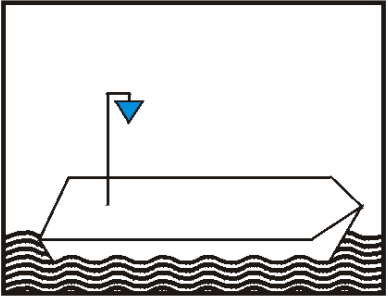
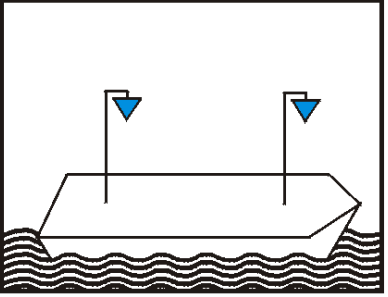
NIGHT	SKETCH	DAY
	<p>28</p>	
<p>Article 3.13, paragraph 5: Small sailing craft less than 7 m long carrying a white light visible from all directions, and on the approach of other vessels displaying a second ordinary white light.</p>		
	<p>29</p>	
<p>Article 3.13, paragraph 6: Small craft proceeding alone, neither motorized nor under sail.</p>		
	<p>30a</p>	
	<p>30b</p>	
<p>Article 3.14, paragraph 1: Additional marking for vessels carrying out certain transport operations involving dangerous substances: flammable substances that are referred to in marginal 10 500 of annex B.1 and appendix 4 (list of substances) of annex B.2 of ADN.</p>		

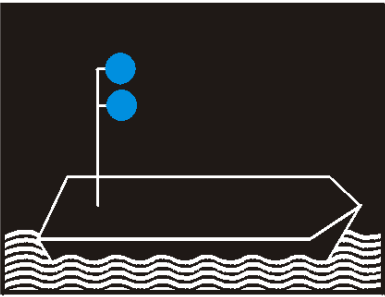
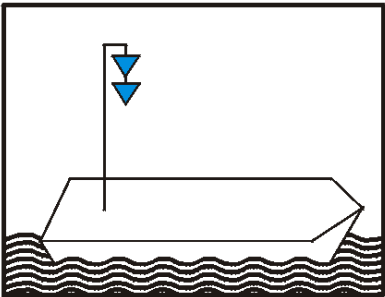
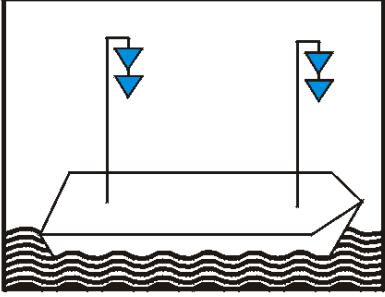
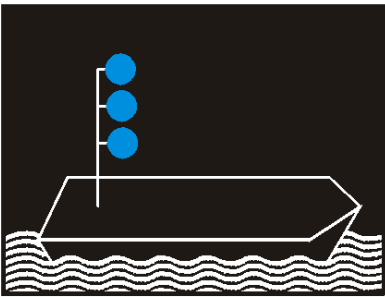
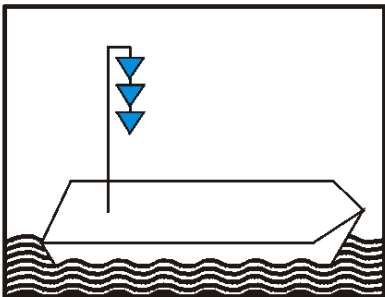
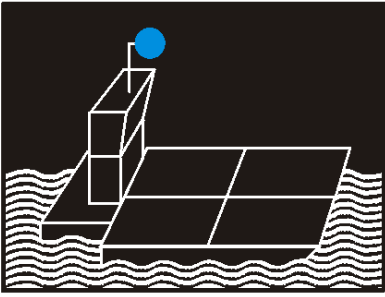
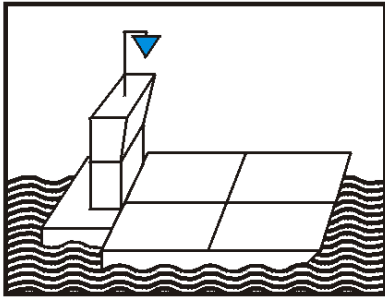
NIGHT	SKETCH	DAY
	<p>31a</p>	
	<p>31b</p>	
<p>Article 3.14, paragraph 2: Additional marking for vessels carrying out certain transport operations involving dangerous substances: substances constituting health hazards that are referred to in marginal 10 500 of annex B.1 and appendix 4 (list of substances) of annex B.2 of ADN.</p>		
	<p>32</p>	
<p>Article 3.14, paragraph 3: Additional marking of vessels carrying out certain transport operations involving dangerous substances: explosives that are referred to in marginal 10 500 of annex B.1 of ADN.</p>		
	<p>33</p>	
<p>Article 3.14, paragraph 4: Additional marking of pushed convoys carrying out certain transport operations involving dangerous substances that are referred to in marginal 10 500 of annex B.1 and appendix 4 (list of substances) of annex B.2 of ADN.</p>		

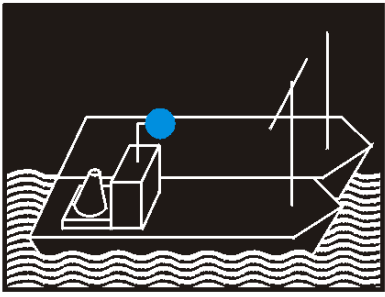
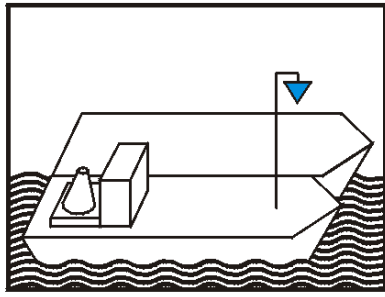
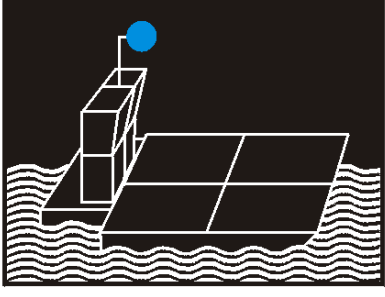
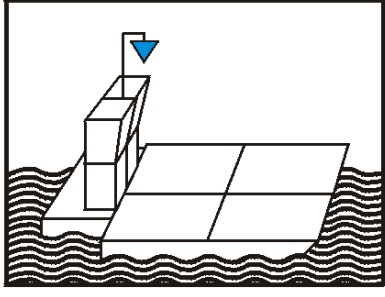
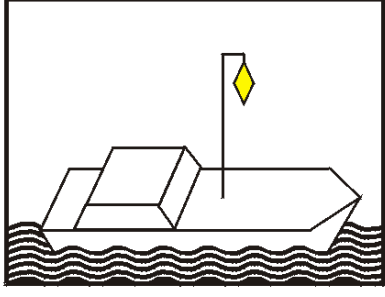
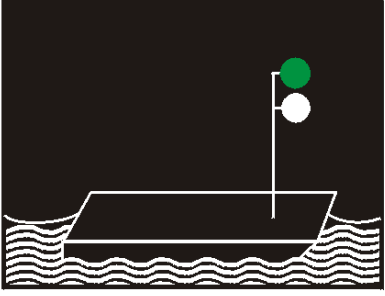
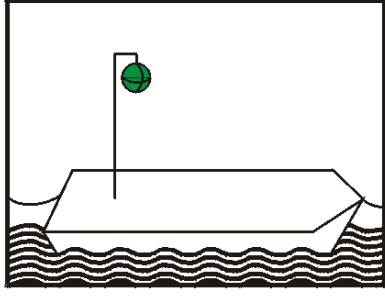
NIGHT	SKETCH	DAY
	34	
<p>Article 3.14, paragraph 4: Additional marking of side-by-side formations carrying out certain transport operations involving dangerous substances that are referred to in marginal 10 500 of annex B.1 and appendix 4 (list of substances) of annex B.2 of ADN.</p>		
	35	
<p>Article 3.14, paragraph 5: Additional marking of pushed convoys propelled by two pushers placed side by side and carrying out certain transport operations involving dangerous substances that are referred to in marginal 10 500 of annex B.1 and appendix 4 (list of substances) of annex B.2 of ADN.</p>		
	36	
<p>Article 3.15: Vessels authorized to carry more than 12 passengers with a maximum hull length of less than 20 m.</p>		
	37	
<p>Article 3.16, paragraph 1: Ferry-boats not moving independently.</p>		

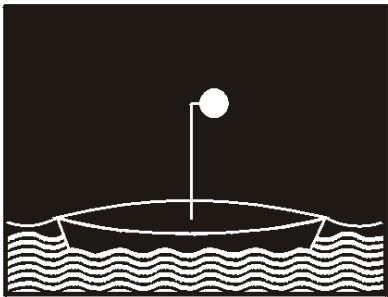
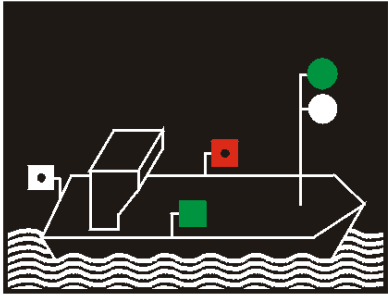
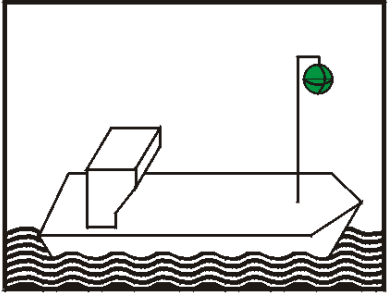
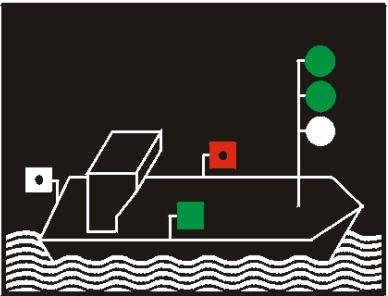
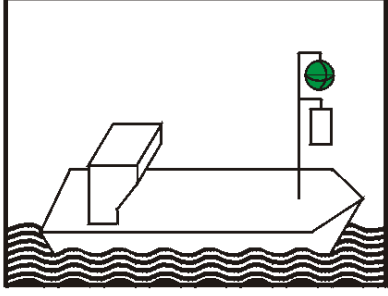
NIGHT	SKETCH	DAY
	38	
Article 3.16, paragraph 2: Leading boat or float of a longitudinal-cable ferry-boat.		
	39	
Article 3.16, paragraph 3: Ferry-boats moving independently.		
	40	
Article 3.16, paragraph 4: Ferry-boats moving independently and enjoying priority.		

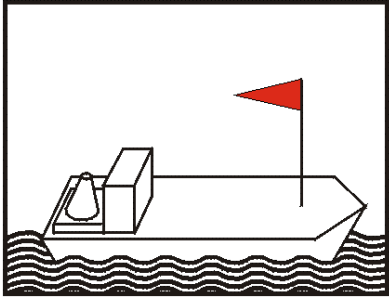
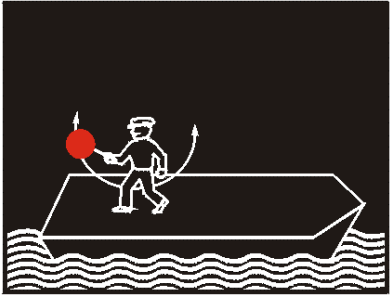
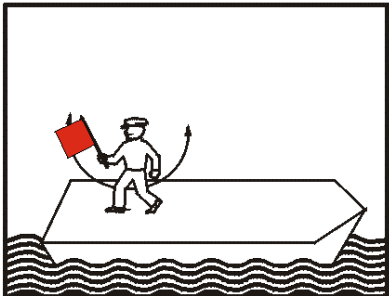
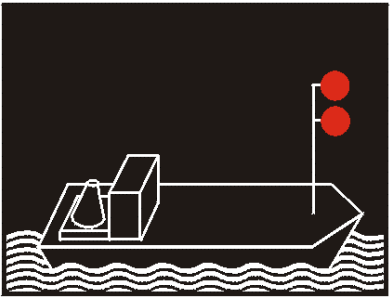
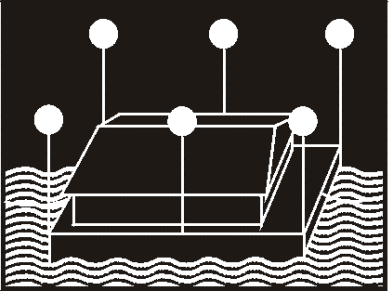
NIGHT	SKETCH	DAY
	41	
Article 3.17: Vessels having priority of passage.		
	42a	
	42b	
Article 3.18, paragraph 1: Additional marking for vessels unable to manoeuvre.		
	43	
Article 3.19: Assemblies of floating material and floating establishments under way.		

NIGHT

SKETCH

DAY

3. MARKING WHEN STATIONARY

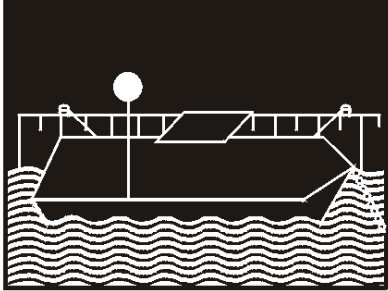
	<p>44</p>	
---	-----------	--

Article 3.20, paragraphs 1 and 4: Vessels directly or indirectly made fast to the bank.

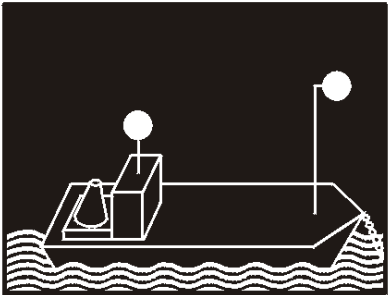
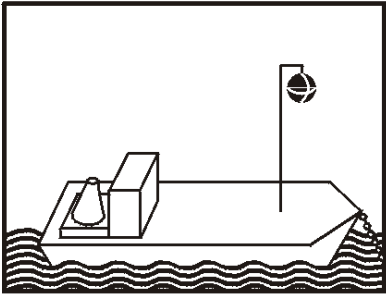
	<p>45</p>	
--	-----------	---

Article 3.20, paragraph 2: Vessels stationary offshore.

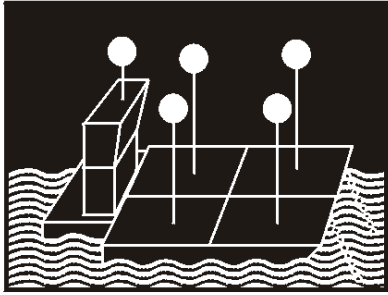
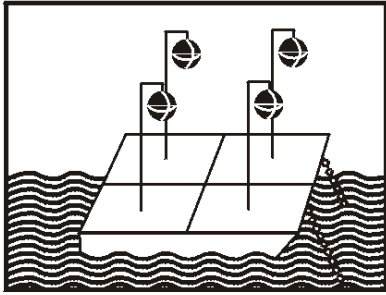
	<p>46</p>	
---	-----------	--

Article 3.20, paragraph 3: Pushed convoys stationary offshore.

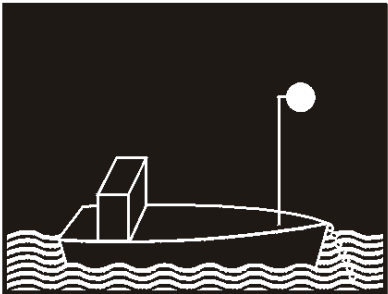
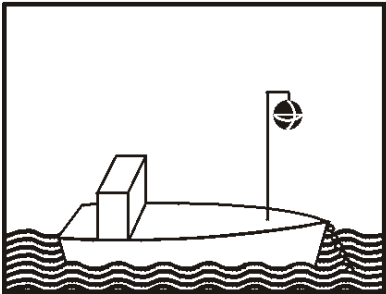
	<p>47</p>	
---	-----------	--

Article 3.20, paragraph 4: Stationary small craft.

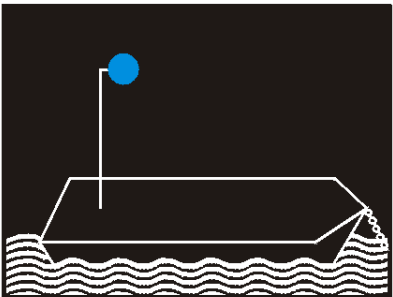
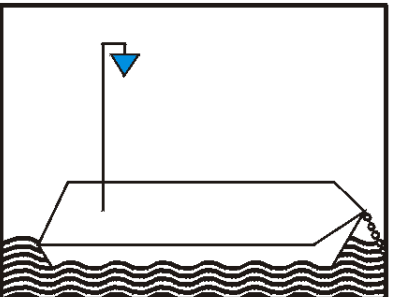
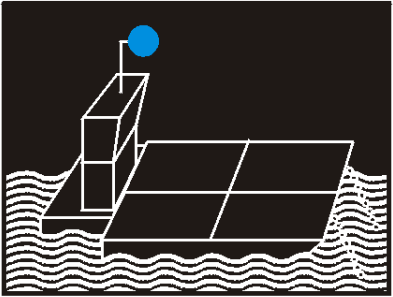
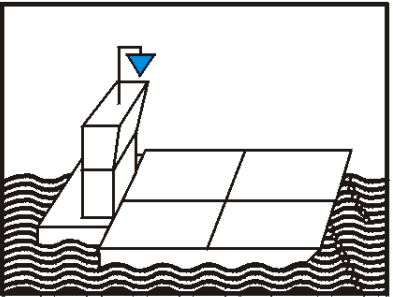
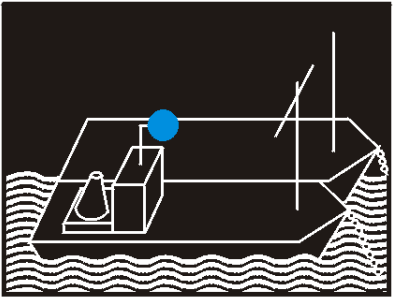
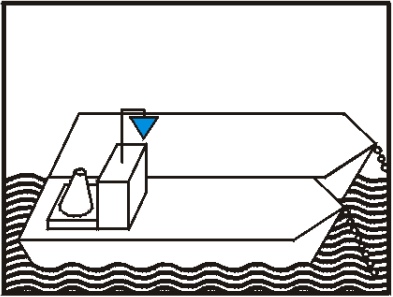
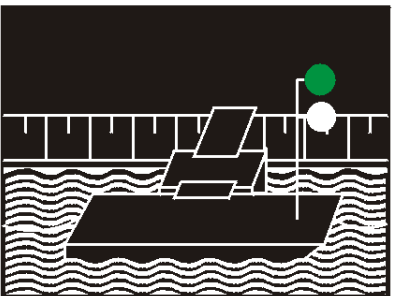
NIGHT	SKETCH	DAY
	48	
<p>Article 3.21: Additional marking for stationary vessels carrying out certain transport operations involving dangerous substances.</p>		
	49	
<p>Article 3.21: Additional marking for stationary pushed convoys carrying out certain transport operations involving dangerous substances.</p>		
	50	
<p>Article 3.21: Additional marking for stationary side-by-side formations carrying out certain transport operations involving dangerous substances.</p>		
	51	
<p>Article 3.22, paragraph 1: Ferry-boats not moving independently when made fast at their landing stage.</p>		

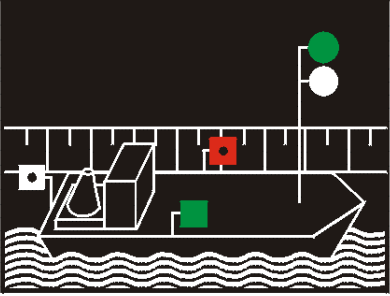
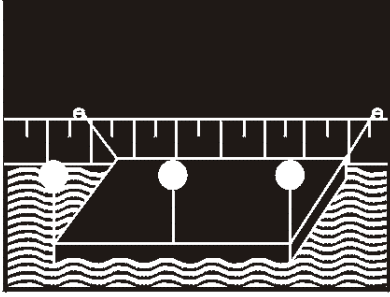
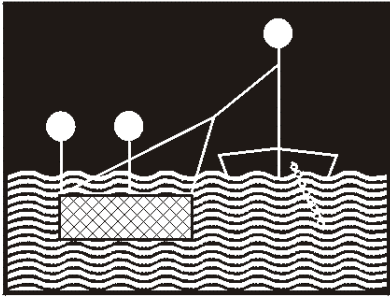
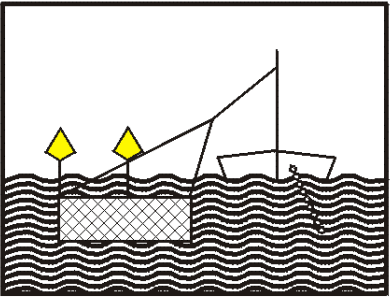
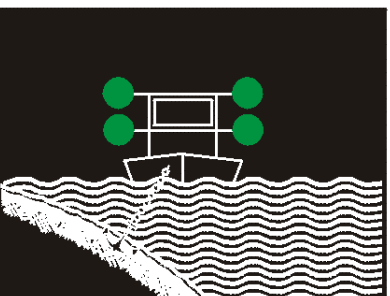
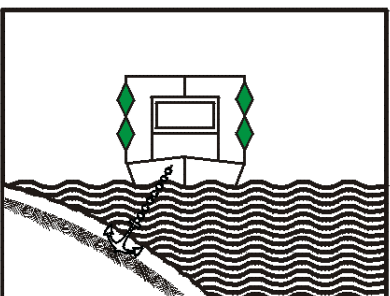
NIGHT	SKETCH	DAY
	52	
<p>Article 3.22, paragraph 2: Ferry-boats moving independently, but made fast at their landing stage.</p>		
	53	
<p>Article 3.23: Assemblies of floating material and floating establishments when stationary.</p>		
	54	
<p>Article 3.24: Stationary vessels engaged in fishing with nets or poles.</p>		
	55	
<p>Article 3.25, paragraph 1, letter a: Floating equipment at work and vessels carrying out work or sounding or measuring operations; channel clear on both sides.</p>		

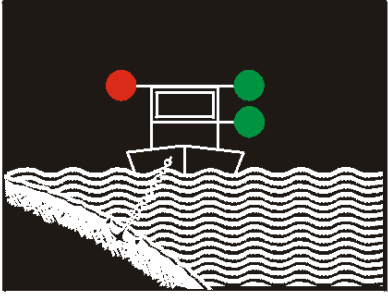
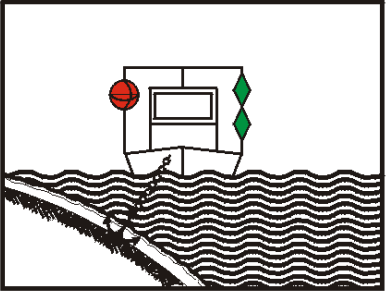
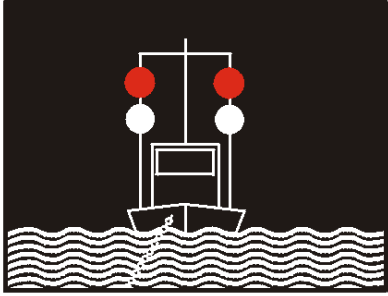
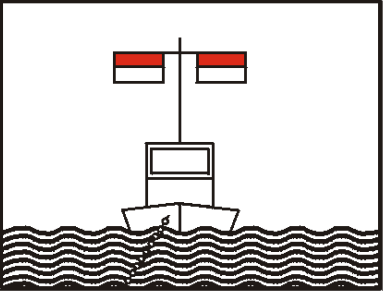
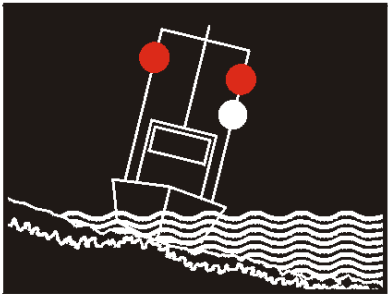
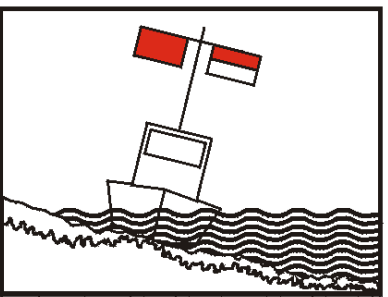
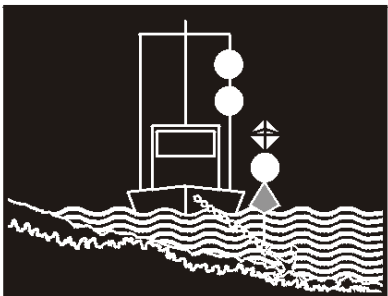
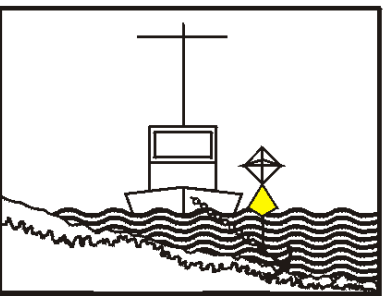
NIGHT	SKETCH	DAY
	<p>56</p>	
<p>Article 3.25, paragraph 1, letters a and b: Floating equipment at work and vessels carrying out work or sounding or measuring operations; channel clear on one side.</p>		
	<p>57</p>	
<p>Article 3.25, paragraph 1, letter c: Floating equipment at work and vessels carrying out work or sounding or measuring operations and grounded or sunken vessels; protection against wash; channel clear on both sides.</p>		
	<p>58</p>	
<p>Article 3.25, paragraph 1, letters c and d: Floating equipment at work and vessels carrying out work or sounding or measuring operations and grounded or sunken vessels; protection against wash; channel clear on one side.</p>		
	<p>59</p>	
<p>Article 3.26: Vessels whose anchors may be a danger to navigation.</p>		

NIGHT

SKETCH

DAY

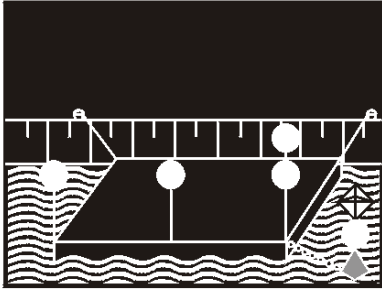

60

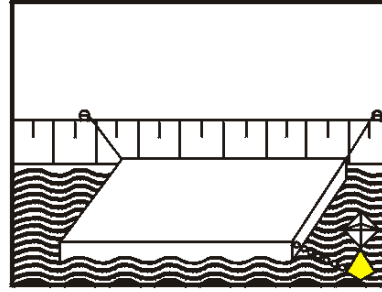

Article 3.26: Assemblies of floating material or floating establishments whose anchors may be a danger to navigation.

NIGHT

SKETCH

DAY

4. SPECIAL MARKING

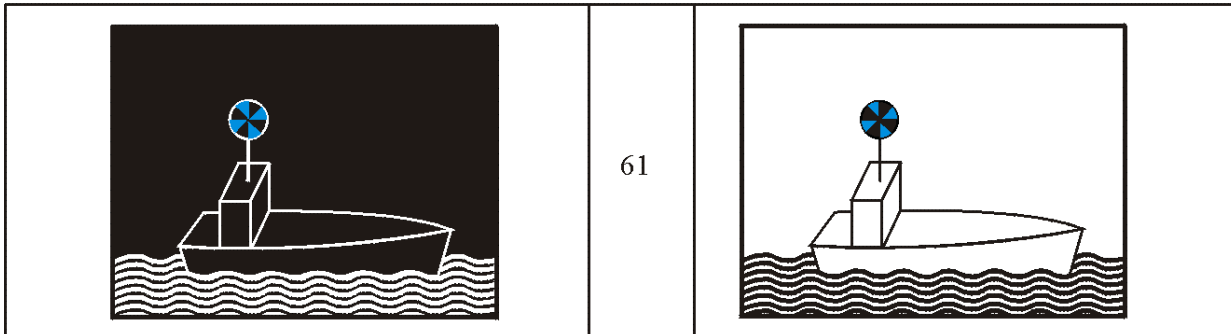



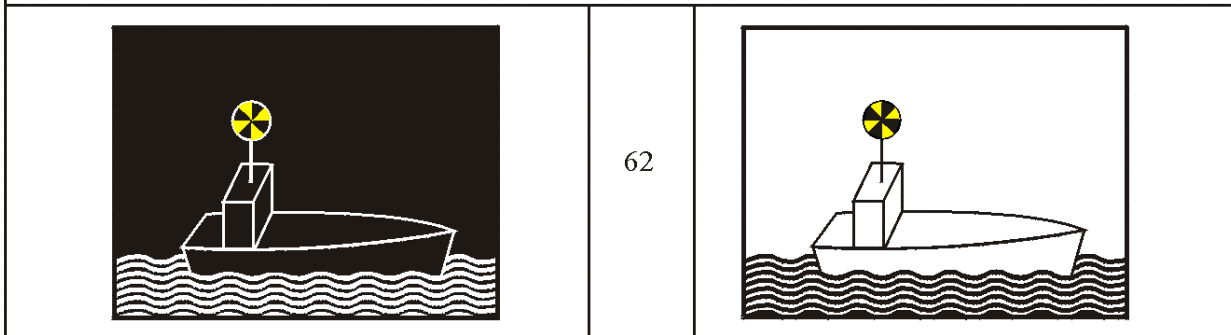

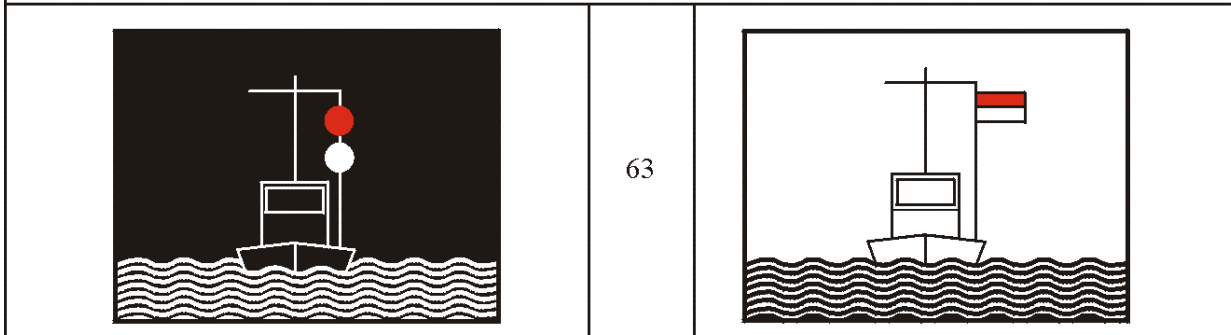

Article 3.27: Additional marking for vessels of the supervisory authorities and fire-fighting services.



Article 3.28: Additional marking for vessels under way carrying out work in the waterway.

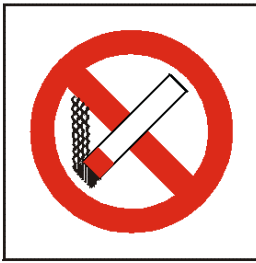
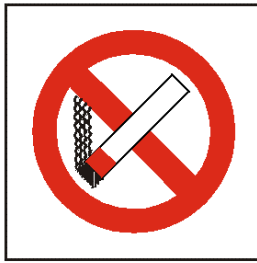

Article 3.29: Additional marking for protection against wash.

NIGHT	SKETCH	DAY
	64	
Article 3.30: Distress signals.		
	65	
Article 3.31: Boarding prohibited.		
	66	
Article 3.32: Smoking prohibited.		
	67	
Article 3.33: Lateral berthing prohibited.		

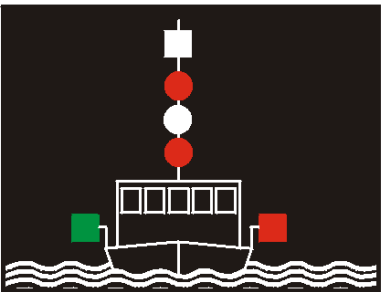
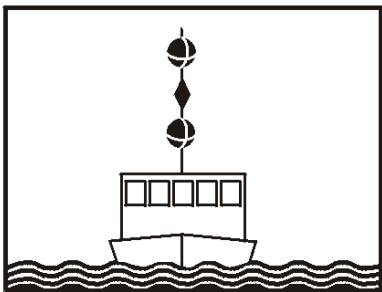
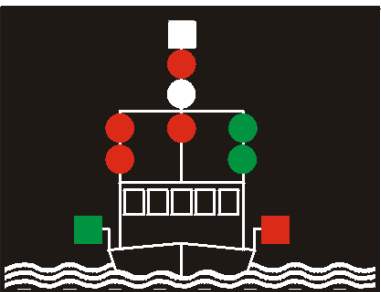
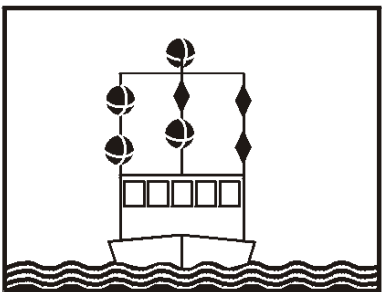
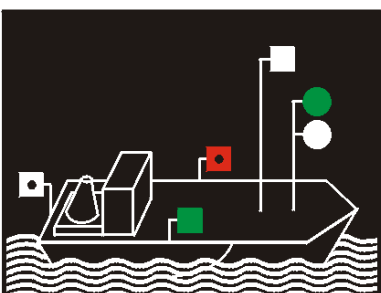
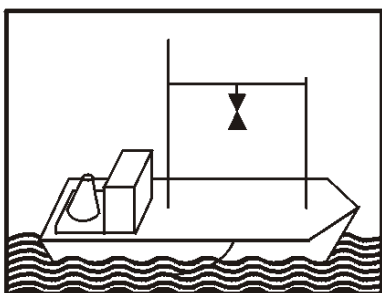
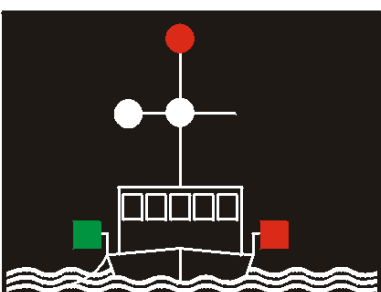
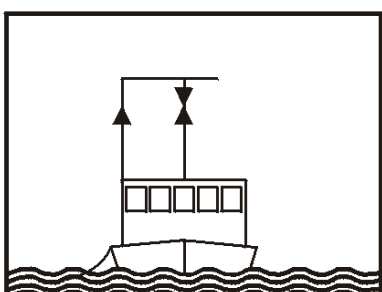
NIGHT	SKETCH	DAY
	68	
<p>Article 3.34, paragraph 1: Additional marking for vessels whose ability to manoeuvre is limited.</p>		
	69	
<p>Article 3.34, paragraph 2: Additional marking for vessels whose ability to manoeuvre is limited; channel clear on one side.</p>		
	70	
<p>Article 3.35, paragraph 1: Additional marking for vessels engaged in drawing a trawl or other fishing gear through the water (trawler).</p>		
	71	
<p>Article 3.35, paragraph 2: Fishing vessels other than trawlers if the fishing tackle extends more than 150 m horizontally from the vessel.</p>		

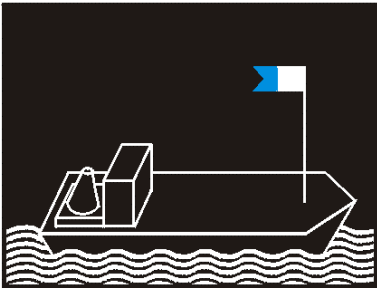
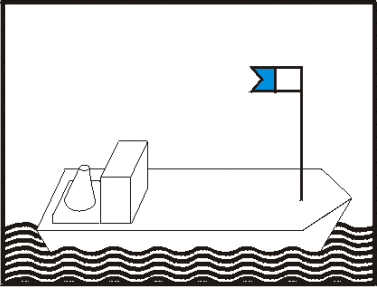
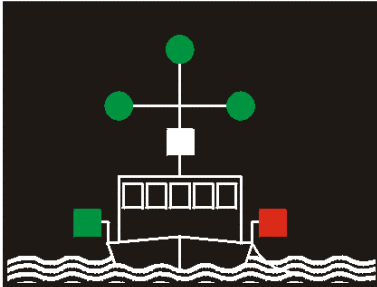
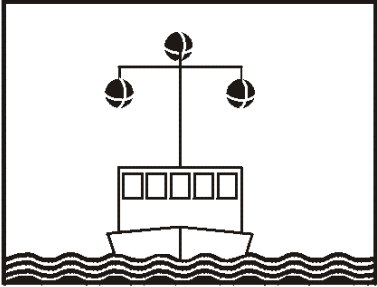
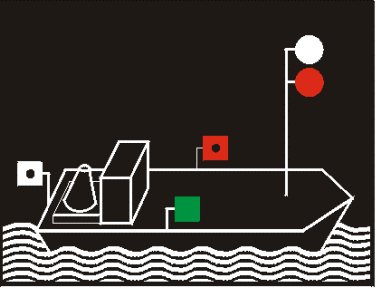
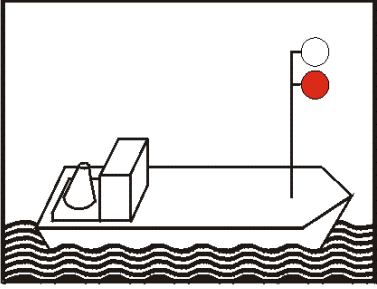
NIGHT	SKETCH	DAY
	72	
<p>Article 3.36: Additional marking for vessels used for underwater diving.</p>		
	73	
<p>Article 3.37: Additional marking for vessels engaged in minesweeping.</p>		
	74	
<p>Article 3.38: Additional marking for vessels on pilotage service.</p>		

Annex 4

LIGHTS AND THE COLOUR OF SIGNAL LIGHTS ON VESSELS¹

I. GENERAL

Definitions

1. Lanterns

A lantern is a device for distributing the flux from a light source; it also includes the components needed to filter, refract or reflect the light, and hold or operate the light source.

Lanterns intended to give signals on board a vessel are called signal lanterns.

2. Signal lights

Signal lights are the light signals emitted by signal lanterns.

3. Light sources

Light sources are electrical or non-electrical devices designed to produce light flux in signal lanterns.

4. Technical requirements

The construction of and materials of signal lanterns shall be such as to ensure their safety and durability.

The components of the lantern (for example the cross braces) shall not modify the intensity, colours or dispersion of the light.

It shall be possible to install the lights on board simply and in the correct position.

It shall be easy to replace the light source.

¹ On the inland waterways of Belarus, Kazakhstan, Lithuania, Republic of Moldova, Russian Federation and Ukraine the colour of signal lights on vessels shall satisfy the requirements of the competent national authorities.

II. COLOUR OF SIGNAL LIGHTS

1. A five colour signal system is applied to the lights, and comprises the following colours:

“white”
“red”
“green”
“yellow” and
“blue”.

This system conforms to the recommendations of the International Commission on Illumination, “Colours of Signal Lights”, IEC publication No. 2.2 (TC-1.6) 1975.

The colours apply to the light fluxes emitted by the lantern.

2. The colour boundaries of signal lights are demarcated by the coordinates (table 1) of the intersecting points of the chromatic diagram of IEC publication No. 2.2 (TC-1.6) 1975 (see chromaticity diagram).

Table 1

Colour of signal light	Coordinates of the intersecting points						
	x	0.310	0.443	0.500	0.500	0.453	0.310
White	y	0.283	0.382	0.382	0.440	0.440	0.348
	x	0.690	0.710	0.680	0.660		
Red	y	0.290	0.290	0.320	0.320		
	x	0.009	0.284	0.207	0.013		
Green	y	0.720	0.520	0.397	0.494		
	x	0.612	0.618	0.575	0.575		
Yellow	y	0.382	0.382	0.425	0.406		
	x	0.136	0.218	0.185	0.102		
Blue	y	0.040	0.142	0.175	0.105		

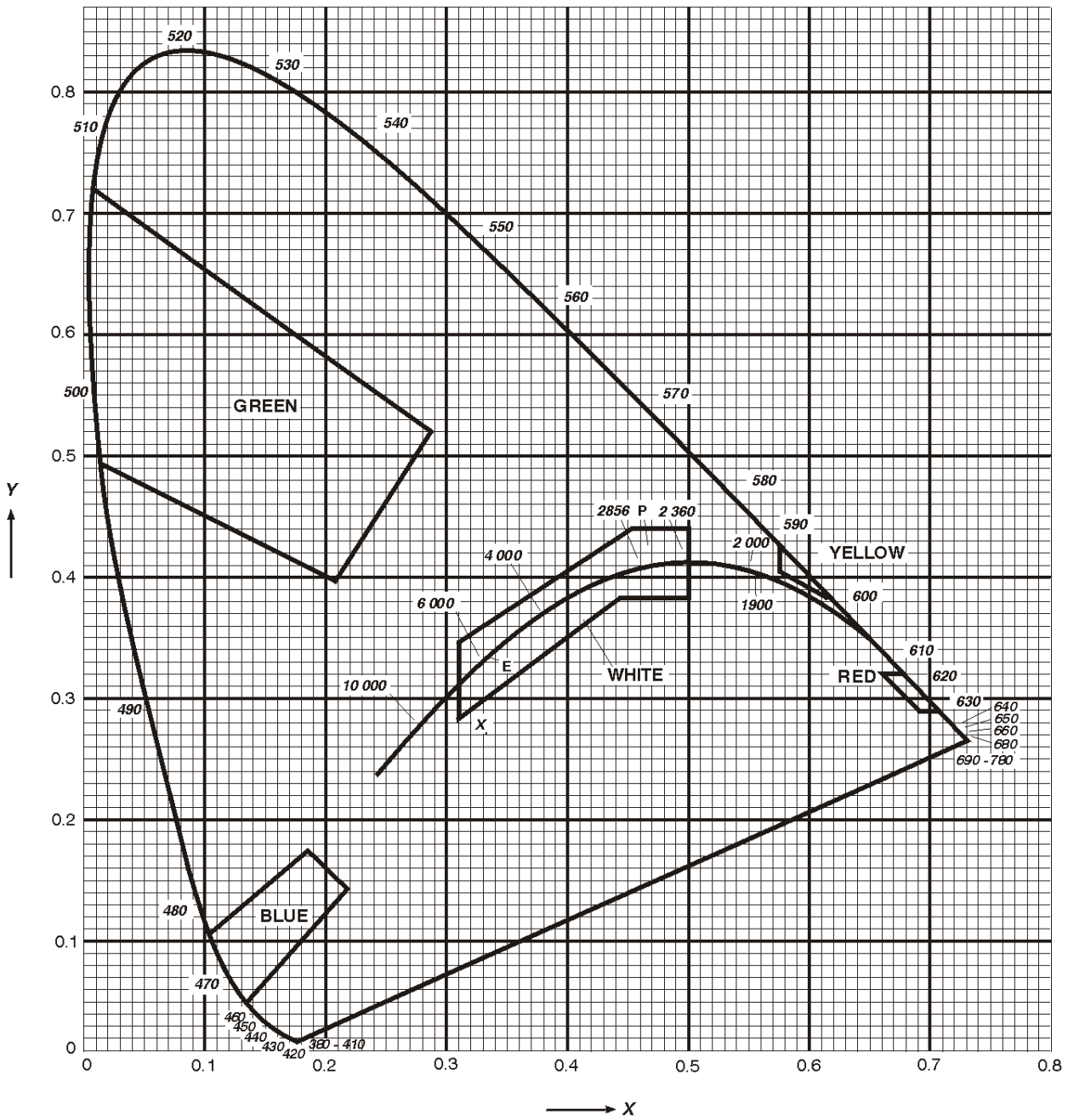

IEC chromaticity diagram

2360 K corresponds to the light of a vacuum filament lamp.
 2848 K corresponds to the light of a gas-filled filament lamp.

Annex 5

INTENSITY AND RANGE OF SIGNAL LIGHTS ON VESSELS¹

I. GENERAL

1. Signal lights

Signal lights are classified according to their luminous intensity as:

“ordinary lights”

“bright lights”

“strong lights”.

2. Relation between I_O , I_B and t

I_O is the photometric luminous intensity in candela (cd), measured at normal voltage for electric lights.

I_B is the operation luminous intensity in candela (cd).

t is the range in kilometres (km).

Taking into account, for example, the ageing of the light source, the degree of dirtiness of the optic and variations in the voltage of the on-board grid, I_B is 25% less than I_O .

Consequently $I_B = 0.75 \cdot I_O$

The relation between I_B and t of signal lights is given by the following equation:

$$I_B = 0.2 \cdot t^2 \cdot q^{-t}$$

The atmospheric transmission coefficient q has been taken as 0.76, corresponding to a meteorological visibility of 14.3 km.

¹ On the inland waterways of Belarus, Kazakhstan, Lithuania, Republic of Moldova, Russian Federation and Ukraine the luminous intensity and range of signal lights on vessels shall satisfy the requirements of the competent national authorities.

II. INTENSITY AND RANGE¹

1. Luminous intensity and range of the signal lights

The following table contains the permitted limits for I_O , I_B and t according to the nature of signal lights. The values indicated apply to the light flux emitted by the lantern.

I_O and I_B are given in cd and t in km.

Minimum and maximum values

Nature of the signal lights		Colour of signal lights							
		white		green/red		yellow		blue	
		min.	max.	min.	max.	min.	max.	min.	max.
ordinary	I_O	2.7	10.0	1.2	4.7	1.1	3.2	0.9	2.7
	I_B	2.0	7.5	0.9	3.5	0.8	2.4	0.7	2.0
	t	2.3	3.7	1.7	2.8	1.6	2.5	1.5	2.3
bright	I_O	12.0	33.0	6.7	27.0	4.8	20.0	6.7	27.0
	I_B	9.0	25.0	5.0	20.0	3.6	15.0	5.0	20.0
	t	3.9	5.3	3.2	5.0	2.9	4.6	3.2	5.0
strong	I_O	47.0	133.0						
	I_B	35.0	100.0						
	t	5.9	8.0						

III. SIGNAL LIGHT DISPERSION

1. Horizontal dispersion of intensity

(a) The luminous intensities indicated in section II apply to all directions of the horizontal plane passing through the focus of the optic or the luminous centre of gravity of the light source correctly adjusted within the operational sector of a vertically positioned lantern;

(b) For the masthead lights, stern lights and side lights, the luminous intensities prescribed shall be maintained throughout the horizontal arc within the sectors prescribed at least up to within 5° of the limits.

¹ On certain inland waterways the competent authority may allow the carriage by vessels of signal lights in accordance with the requirements of IMO.

As from 5° within the sectors prescribed up to the limit, the luminous intensity may decrease by 50%; it shall subsequently decrease gradually in such a way that, as from 5° beyond the limits of the sector, only a negligible amount of light remains;

(c) The side lights shall have the prescribed luminous intensity in the direction parallel to the axis of the vessel forward. The intensities shall decrease practically to zero between 1° and 3° beyond the limits of the prescribed sector;

(d) For bicoloured or tricoloured lanterns, the dispersion of the luminous intensity shall be uniform so that 3° on either side of the prescribed sector limits, the maximum permitted intensity is not exceeded and the minimum prescribed intensity is reached;

(e) The horizontal dispersion of the luminous intensity of the lanterns shall be uniform throughout the sector, so that the minimum and maximum values observed do not differ more than by a factor of 1.5 from the photometric luminous intensity.

2. Vertical dispersion of intensity

In the event of heeling of up to $\pm 5^\circ$ or $\pm 7.5^\circ$ from the horizontal, the luminous intensity shall remain at least equal to 80% in the first case, and 60% in the second case, of the luminous intensity corresponding to 0° heeling, although it shall not exceed it by more than 1.2 times.

Annex 6

SOUND SIGNALS

I. SOUND INTENSITY OF SIGNALS

Mechanically-operated sound signalling devices used by inland waterway vessels shall be capable of producing sound signals with the following characteristics:

1. Frequency

(a) For motorized vessels other than the small craft referred to in paragraph (b), the fundamental frequency shall be 200 Hz, with a tolerance of $\pm 20\%$;

(b) For non-motorized vessels and small craft the fundamental frequency shall be above 350 Hz;

(c) For the three-tone signals used by vessels navigating by radar under conditions of reduced visibility, the fundamental frequencies of the tones shall be between 165 and 297 Hz, with an interval of at least two full tones between the highest-pitched and the lowest-pitched sound.

2. Sound pressure level

The sound pressure levels given below shall be measured at, or referred to, a point 1 metre in front of the centre of the opening of the horn, the measurement being made, as far as possible, away from any sound-reflecting surfaces.

(a) For motorized vessels other than the small craft referred to in paragraph (b), the weighted sound pressure level shall be between 120 and 140 dB (A);

(b) For non-motorized vessels and small craft which are not equipped or used to tow vessels other than small craft, the weighted sound pressure level shall be between 100 and 125 dB (A);

(c) For the three-tone signals used by vessels navigating by radar under conditions of reduced visibility, the weighted sound pressure level of each tone shall be between 120 and 140 dB (A).

II. MONITORING OF SOUND PRESSURE LEVEL

The sound pressure level shall be checked by the competent authorities by means of the sonometer standardized by the International Electrotechnical Commission (reference IEC.179) or by means of the ordinary sonometer standardized by IEC (reference IEC.123).

III. SOUND SIGNALS TO BE USED BY VESSELS

Sound signals other than the ringing of a bell and the three-tone signal shall consist in the emission of one blast or of several successive blasts having the following characteristics:

- short blast: a blast lasting about one second;
- long blast: a blast lasting about four seconds.

The interval between two successive blasts shall be about one second except for the signal “series of very short blasts” which shall comprise a series of not less than six blasts, each lasting about a quarter of a second, separated by a silence of the same duration.

A. *General signals*



1 long blast

"Caution"



1 short blast

"I am altering my course to starboard"



2 short blasts

"I am altering my course to port"



3 short blasts

"I am going astern"



4 short blasts

"I am unable to manoeuvre"



Series of very short blasts

"Imminent danger of collision"



Repeated long blasts)

)

)

)

)

)

)

)



Peals of a bell

"Distress signal"

Article 4.01, paragraph 4

B. *Meeting signals*

B.1 *Waterways of class I*
First case

■	1 short blast by vessel proceeding upstream	"I wish to pass on the port side"	Article 6.04, paragraph 4
■	1 short blast by vessel proceeding downstream	"Agreed; pass on the port side"	Article 6.04, paragraph 5
■ ■	2 short blasts by vessel proceeding downstream	"No; pass on the starboard side"	Article 6.05, paragraph 2
■ ■	2 short blasts by vessel proceeding upstream	"Agreed; I will pass on the starboard side"	Article 6.05, paragraph 3

Second case





■ ■	2 short blasts by vessel proceeding upstream	"I wish to pass on the starboard side"	Article 6.04, paragraph 4
■ ■	2 short blasts by vessel proceeding downstream	"Agreed; pass on the starboard side"	Article 6.04, paragraph 5
■	1 short blast by vessel proceeding downstream	"No; pass on the port side"	Article 6.05, paragraph 2
■	1 short blast by vessel proceeding upstream	"Agreed; I will pass on the port side"	Article 6.05, paragraph 3

B.2 *Waterways of class II*





■ ■	2 short blasts	"I wish to pass on the starboard side"	Article 6.05, paragraph 2
■ ■	2 short blasts by vessel met	"Agreed; pass on the starboard side"	Article 6.05, paragraph 3

C. *Overtaking signals*

First case

	2 long blasts followed by 2 short blasts, by overtaking vessel	"I wish to overtake on your port side"	Article 6.10, paragraph 4
	1 short blast by vessel to be overtaken	"Agreed; overtake on my starboard side"	Article 6.10, paragraph 5
	2 short blasts by vessel to be overtaken	"No; overtake on my starboard side"	Article 6.10, paragraph 6
	1 short blast by overtaking vessel	"Agreed; I will pass on your starboard side"	Article 6.10, paragraph 6

Second case

	2 long blasts followed by 1 short blast by overtaking vessel	"I wish to pass on your starboard side"	Article 6.10, paragraph 4
	2 short blasts by vessel to be overtaken	"Agreed; overtake on my starboard side"	Article 6.10, paragraph 5
	1 short blast by vessel to be overtaken	"No; overtaken on my port side"	Article 6.10, paragraph 6
	2 short blasts by overtaking vessel	"Agreed; I will overtake on your port side"	Article 6.10, paragraph 6

Overtaking impossible



	5 short blasts by vessel to be overtaken	"I cannot be overtaken"	Article 6.10, paragraph 7
---	--	-------------------------	---------------------------

D. *Turning signals*

	1 long blast followed by 1 short blast	"I am going to turn to starboard"	Article 6.13, paragraph 2
	1 long blast followed by 2 short blasts	"I am going to turn to port"	Article 6.13, paragraph 2

E. *Harbours and tributary waterways: entering and leaving, followed by crossing the waterway*

E.1 *Signals on entering and leaving harbours and tributary waterways*

	3 long blasts followed by 1 short blast	"I am going to starboard"	Article 6.16, paragraph 2
	3 long blasts followed by 2 short blasts	"I am going to port"	Article 6.16, paragraph 2

E.2 *Signals on crossing after entering the waterway*

	3 long blasts	"I am going to cross"	Article 6.16, paragraph 2
---	---------------	-----------------------	------------------------------

followed if necessary by:

	1 long blast followed by 1 short blast	"I am going to starboard"	Article 6.16, paragraph 2
	1 long blast followed by 2 short blasts	"I am going to port"	Article 6.16, paragraph 2

F. *Signals in reduced visibility*

F.1 *Waterways of class I*

(a) *Vessels navigating by radar*

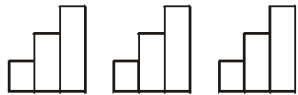

(i) Vessels, other than small craft, proceeding downstream

Three-tone signal repeated as often as necessary

Article 6.32, paragraph 4 (a)



(ii) Single vessel proceeding upstream

1 long blast

Article 6.32, paragraph 5 (a)

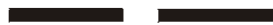

(iii) Convoys proceeding upstream

2 long blasts

Article 6.32, paragraph 5 (a)

(b) *Vessels not navigating by radar*



(i) Any vessel proceeding alone

1 long blast repeated at least once a minute

Article 6.33, paragraph 2



(ii) Convoys

2 long blasts repeated at least once a minute

Article 6.33, paragraph 2

(c) *Stationary vessels*



1 peal of a bell, repeated at least once a minute

"I am lying on left side of channel"

Article 6.31, paragraph 1 (a)



2 peals of a bell, repeated at least once a minute

"I am lying on right side of channel"

Article 6.31, paragraph 1 (b)



3 peals of a bell, repeated at least once a minute

"I am stationary, position uncertain"

Article 6.31, paragraph 1 (c)

F. *Signals in reduced visibility (continued)*

F.2 *Waterways of class II*
 (a) *Vessels navigating by radar*



(i) Vessels, other than ferry-boats 1 long blast repeated as often as necessary Article 6.32, paragraph 4 (a)



(ii) Ferry-boats 1 long blast followed by 4 short blasts Article 6.32, paragraph 5

(b) *Vessels not navigating by radar*



(i) Single vessels other than ferry-boats 1 long blast repeated at least once a minute Article 6.33, paragraph 2



(ii) Convoys 2 long blasts repeated at least once a minute Article 6.33, paragraph 2



(iii) Ferry-boats 1 long blast followed by 4 short blasts, repeated at least once a minute Article 6.33, paragraph 4

(c) *Stationary vessels*



1 peal of a bell, or 1 long blast between 2 short blasts, repeated at least once a minute Article 6.31, paragraphs 1 and 4

Annex 7

WATERWAY SIGNS AND MARKING¹

(1) The main signs given in section I below may be supplemented or clarified by auxiliary signs given in section II.

(2) Boards may be surrounded by a thin white line.

Section I. MAIN SIGNS

A. PROHIBITORY SIGNS

A.1 No entry (general sign)
(see articles 6.08, 6.16, 6.22, 6.22 bis,
6.25, 6.26, 6.27 and 6.28 bis)



boards
or red lights

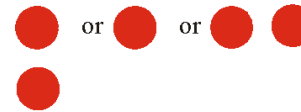

Two boards, two lights or two flags,
one above the other, indicate a
prolonged prohibition

or red flags

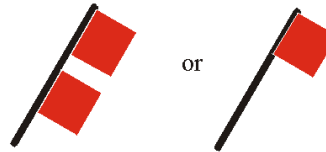

A.2 No overtaking
(see article 6.11)

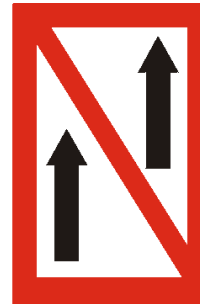

A.3 No overtaking of convoys by convoys
(see article 6.11)

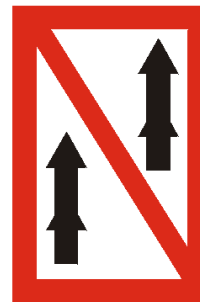

¹ Waterway signs and marking in the Russian Federation and Ukraine correspond to national rules.

A.4 No passing or overtaking
(see article 6.08)



A.5 No berthing
(i.e. no anchoring or making fast to the bank)
(see article 7.02)



A.5.1 No berthing within the breadth indicated in metres
(measured from the sign)
(see article 7.02)



A.6 No anchoring or trailing of anchors, cables or chains
(see articles 6.18 and 7.03)

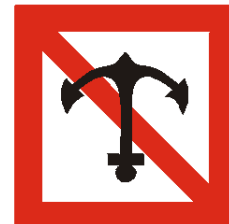

A.7 No making fast to the bank
(see article 7.04)



A.8 No turning
(see article 6.13)

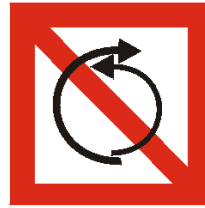

A.9 Do not create wash
(see article 6.20)

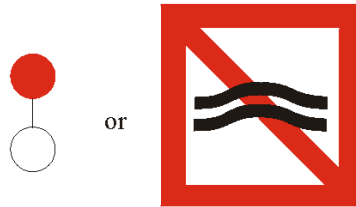

A.10 No passing outside the area marked
(in openings of bridges or weirs)
(see article 6.24)



A.11 Entry prohibited, but prepare
to get under way
(see articles 6.26 and 6.28 *bis*)

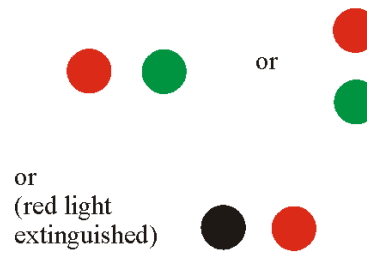

A.12 Motorized craft prohibited

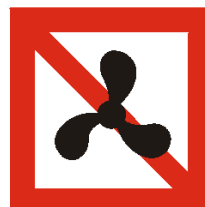

A.13 All sports or pleasure craft prohibited¹



A.14 Water skiing prohibited



A.15 Sailing vessels prohibited



A.16 All craft other than motorized vessels or sailing craft prohibited



A.17 Use of sailboards prohibited



¹ The competent authorities may also use this board to prohibit small craft.

A.18 End of zone authorized for high speed navigation of small sport and pleasure craft



A.19 No launching or beaching of vessels



A.20 Water bikes prohibited



B. MANDATORY SIGNS

B.1 Proceed in the direction shown by the arrow
(see article 6.12)

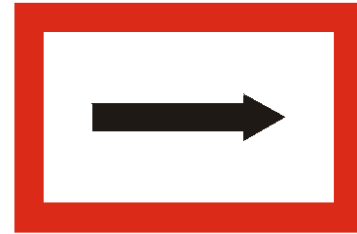

B.2

(a) Move to the side of the channel
on your port side
(see article 6.12)

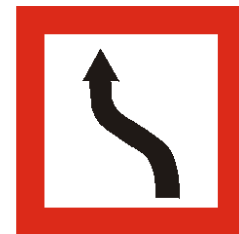

(b) Move to the side of the channel
on your starboard side
(see article 6.12)

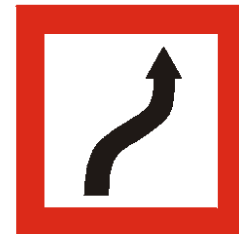

B.3

(a) Keep to the side of the channel
on your port side
(see article 6.12)

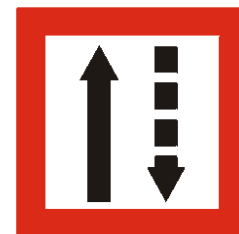

(b) Keep to the side of the channel
on your starboard side
(see article 6.12)

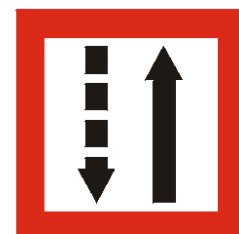

B.4

- (a) Cross channel to port
(see article 6.12)

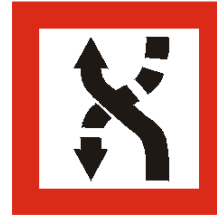

- (b) Cross channel to starboard
(see article 6.12)



- B.5 Stop as prescribed in the Regulations
(see articles 6.26 and 6.28)

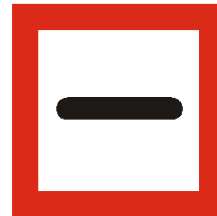

- B.6 Do not exceed the speed indicated
(in km/h)



- B.7 Give a sound signal

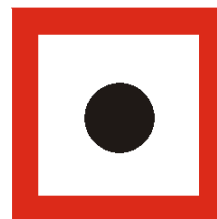

B.8 Keep a particularly sharp lookout
(see article 6.08)



B.9 Do not enter or cross the main
waterway until certain that this
will not oblige vessels proceeding
on it to change their course or speed
(see article 6.16)

)
)
)
)
) (a)
)
)
)
)
)
) (b)
)
)
)
)



B.10 Vessels proceeding on the main waterway must,
if necessary, change course and speed to allow
vessels to leave harbours or tributary waterways
(see article 6.16)



B.11 (a) Obligation to enter into a radiotelephone
link
(see article 4.04, paragraph 4)



(b) Obligation to enter into a radiotelephone
link on the channel as indicated on the board
(see article 4.04, paragraph 4)



C. RESTRICTIVE SIGNS

C.1 Depth of water limited



C.2 Headroom limited



C.3 Width of passage or channel limited

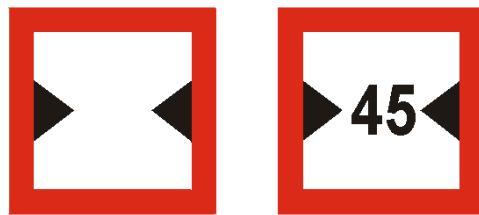

Note: Boards C.1, C.2 and C.3 may carry, in addition, figures indicating in metres the depth of water, the headroom and the width of passage or the channel respectively.

C.4 There are restrictions on navigation: make enquiries



C.5 The channel lies at a distance from the right (left) bank; the figure shown on the sign indicates the distance in metres, measured from the sign, to which vessels should keep



D. RECOMMENDATORY SIGNS

D.1 Recommended channel

(a) In both directions
(see articles 6.25, 6.26 and 6.27)

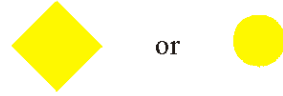

(b) Only in the direction indicated
(passage in the opposite direction prohibited)
(see articles 6.25, 6.26 and 6.27)

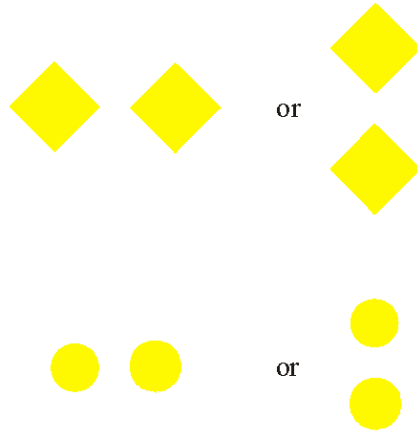

D.2 You are recommended to keep
within the area indicated
(in openings of bridges or weirs)
(see article 6.24)

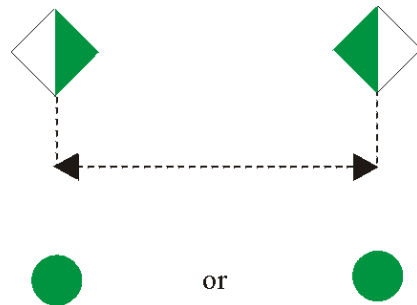

D.3 You are recommended to proceed:

In the direction shown by the arrow

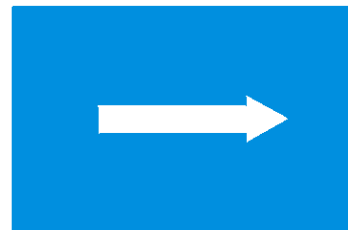

In the direction from the fixed light
towards the isophase light



E. INFORMATIVE SIGNS

E.1 Entry permitted (general sign)
(see articles 6.08, 6.16, 6.26,
6.27 and 6.28 *bis*)



E.2 Overhead cable crossing



E.3 Weir

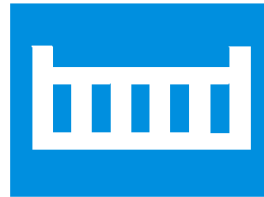

E.4

(a) Ferry-boat not moving independently

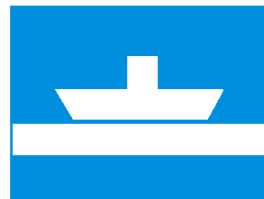

(b) Ferry-boat moving independently

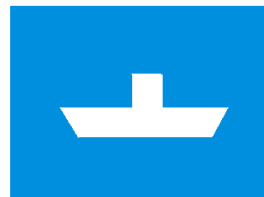

E.5 Berthing (i.e. anchoring or making fast to the bank) permitted (see articles 7.02 and 7.05)



E.5.1 Berthing permitted on the stretch of water of the breadth measured from, and shown on the board in metres (see article 7.05)



E.5.2 Berthing permitted on the stretch of water bounded by the two distances measured from, and shown on the board in metres (see article 7.05)



E.5.3 Maximum number of vessels permitted to berth abreast (see article 7.05)



E.5.4 Berthing area reserved for pushing-navigation vessels that are not required to carry the marking prescribed in article 3.14 (see article 7.06)

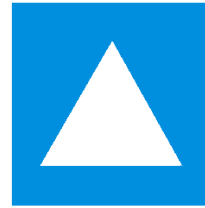

E.5.5 Berthing area reserved for pushing-navigation vessels that are required to carry one blue light or one blue cone under article 3.14, paragraph 1 (see article 7.06)

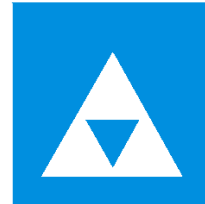

E.5.6 Berthing area reserved for pushing-navigation vessels that are required to carry two blue lights or two blue cones under article 3.14, paragraph 2 (see article 7.06)



E.5.7 Berthing area reserved for pushing-navigation vessels that are required to carry three blue lights or three blue cones under article 3.14, paragraph 3 (see article 7.06)

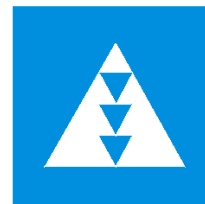

E.5.8 Berthing area reserved for vessels other than pushing-navigation vessels that are not required to carry the marking prescribed in article 3.14 (see article 7.06)



E.5.9 Berthing area reserved for vessels other than pushing-navigation vessels that are required to carry one blue light or one blue cone under article 3.14, paragraph 1 (see article 7.06)



E.5.10 Berthing area reserved for vessels other than pushing-navigation vessels that are required to carry two blue lights or two blue cones under article 3.14, paragraph 2 (see article 7.06)

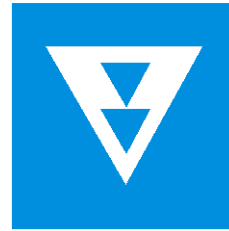

E.5.11 Berthing area reserved for vessels other than pushing-navigation vessels that are required to carry three blue lights or three blue cones under article 3.14, paragraph 3 (see article 7.06)



E.5.12 Berthing area reserved for all vessels that are not required to carry the marking prescribed in article 3.14 (see article 7.06)

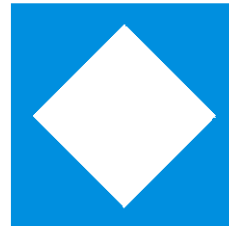

E.5.13 Berthing area reserved for all vessels that are required to carry one blue light or one blue cone under article 3.14, paragraph 1 (see article 7.06)

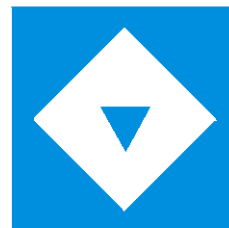

E.5.14 Berthing area reserved for all vessels that are required to carry two blue lights or two blue cones under article 3.14, paragraph 2 (see article 7.06)

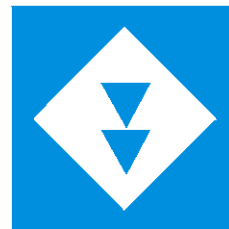

E.5.15 Berthing area reserved for all vessels that are required to carry three blue lights or three blue cones under article 3.14, paragraph 3 (see article 7.06)

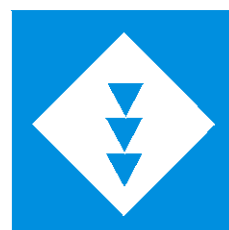

E.10 This waterway is considered to be a tributary of the waterway being approached (see article 6.16)

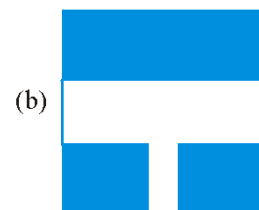
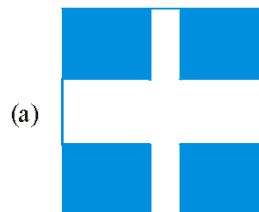

E.11 End of a prohibition or obligation applying to traffic in one direction only, or end of a restriction



E.12 Advance signals: one or two white lights

(a) Fixed light(s): Difficulty ahead - stop if the regulations so require

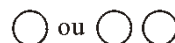

(b) Isophase light(s): You may proceed



E.13 Drinking-water supply



E.14 Telephone



E.15 Motorized vessels permitted



E.16 Sports or pleasure craft permitted¹



E.17 Water skiing permitted



E.18 Sailing vessels permitted



E.19 Craft other than motorized vessels
or sailing craft permitted



E.20 Use of sailboards permitted



¹ The competent authorities may also use this board to permit small craft.

E.21 Zone authorized for high speed navigation
of small sport and pleasure craft



E.22 Launching or beaching of vessels permitted

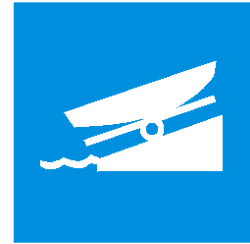

E. 23 Possibility of obtaining nautical information
by radio-telephone on the channel indicated



E.24 Water bikes permitted



Section II. AUXILIARY SIGNS

The main signs (see section I) may be supplemented by the following auxiliary signs:

1. *Panels showing the distance at which the regulation applies or the special feature indicated by the main sign is to be found*

Note: The panels are placed above the main sign.

Examples :

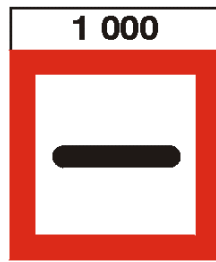

In 1,000 m, stop

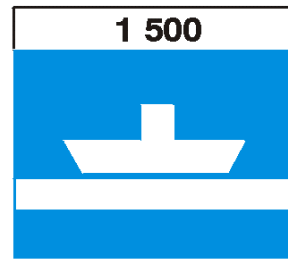

In 1,500 m, ferry-boat
not moving independently

2. *Additional luminous signal*

Luminous white arrow combined with certain lights, with the following meanings:

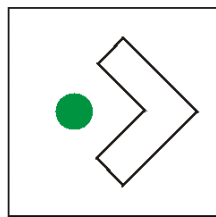
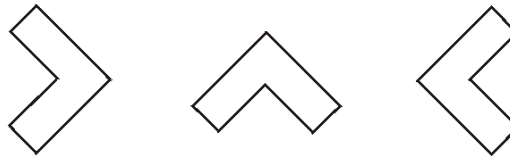

(a) *With green light*

Example: Permission to enter the basin
to which the arrow is pointing

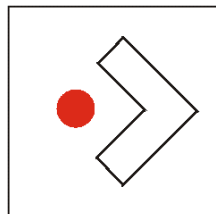

(b) *With red light*

Example: No entry to the basin
the arrow is pointing

3. *Pointers showing the direction of the section to which the main sign applies*

Note: The pointers need not necessarily be white and may be placed beside or below the main sign.

Examples:

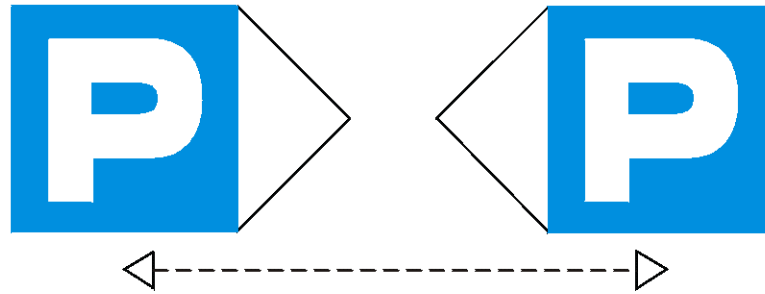

Berthing permitted

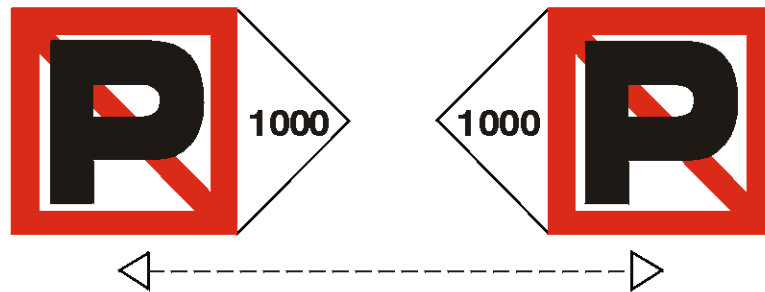

Berthing prohibited (over a distance of 1,000 m)

4. *Panels giving explanations or additional information*

Note: These panels are placed below the main sign.



Examples:



Stop for Customs



Give one long blast

Annex 8

BUOYAGE AND MARKING OF WATERWAYS, LAKES AND BROAD WATERWAYS

I. GENERAL

1. Definitions

Right-hand side/left-hand: the designations "right-hand side" and "left-hand side" of the waterway or channel are to be understood as for an observer facing downstream;

on canals, lakes and broad waterways the terms "right" and "left" shall be defined by the authorities.

Light: a distinctive light used as a marking.

Fixed light: an uninterrupted light of constant intensity and colour.

Rhythmic light: a light of constant intensity and colour operating in a characteristic and regularly repeated succession of spells of illumination and extinction.

2. Rhythm of lights

Examples:

Single-occulting light



Group-occulting light



Isophase light



Single-flashing light



Group-flashing light



Composite group-flashing light



Continuous scintillating light or continuous quick scintillating light))



Group scintillating light or group quick scintillating light))))))))



* In this instance, a long flash permits clear differentiation of the rhythm.

II. BUOYAGE OF CHANNEL LIMITS IN THE WATERWAY

1. Right-hand side of the channel

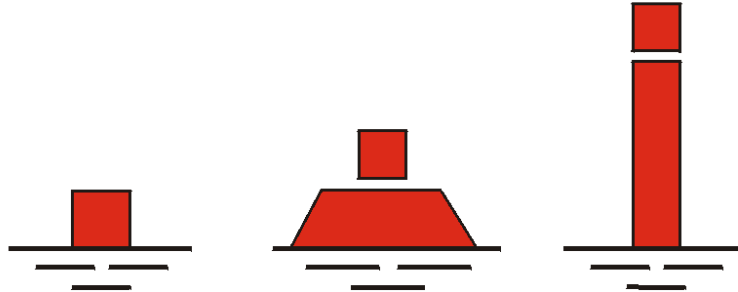

(fig. 1)

Colour: red

Form: cylindrical buoy or buoy with a topmark, or spar

Topmark (if any): red cylinder

Light (when fitted): rhythmic red light

Generally with radar reflector.

2. Left-hand side of the channel

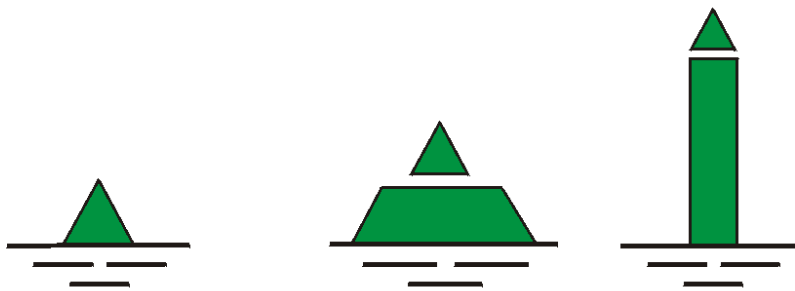

(fig. 2)

Colour: green

Form: conical buoy or buoy with a topmark, or spar

Topmark (if any): green cone, point upwards

Light (when fitted): rhythmic green light

Generally with radar reflector.

3. Bifurcation of the channel

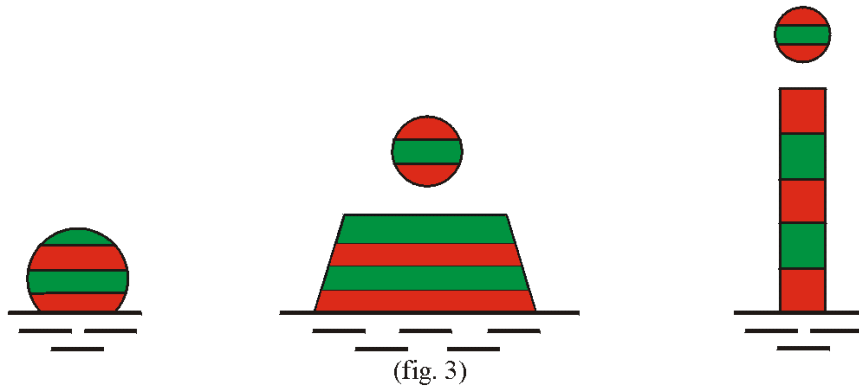

Colour: horizontal red and green bands

Form: spherical buoy or buoy with a topmark, or spar

Topmark (if any): sphere with horizontal red and green bands

Light (when fitted): continuous scintillating white light, or isophase white light
(may be the group-flashing white light with a group of three flashes)

Generally with radar reflector.

Where necessary, a red cylindrical topmark or green conical topmark placed above the bifurcation mark indicates on which side it is preferable to pass (main channel).

The mark shall then bear a rhythmic red light or a rhythmic green light, as appropriate.

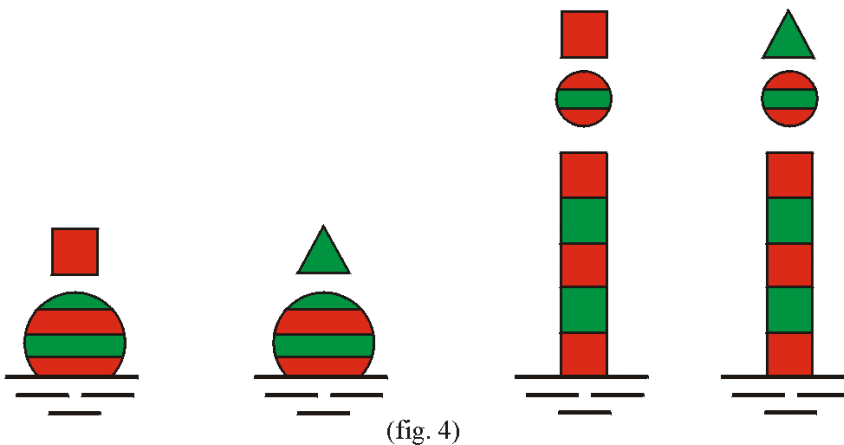

4. A letter "p" painted in white on the buoys described in paragraphs 1 and 2 indicates that the channel is adjacent to a berthing area. If the buoys showing the letter "P" carry a light, its rhythm shall be different from that of the lights of other buoys placed along the channel limit.

III. MARKS ON LAND INDICATING THE POSITION OF THE CHANNEL

A. *Marks on land indicating the position of the channel in relation to the banks*

These marks indicate the position of the channel in relation to the bank and, together with the buoyage of the waterway, mark the channel at points where it approaches a bank; they also serve as landmarks.

1. Channel near the right bank



(fig. 5)

Colour: red/white

Form: post with topmark

Topmark: square boards (sides horizontal and vertical), red, with two horizontal white stripes;
or square frame (sides horizontal and vertical), painted red

Light (when fitted): rhythmic red light.

2. Channel near the left bank

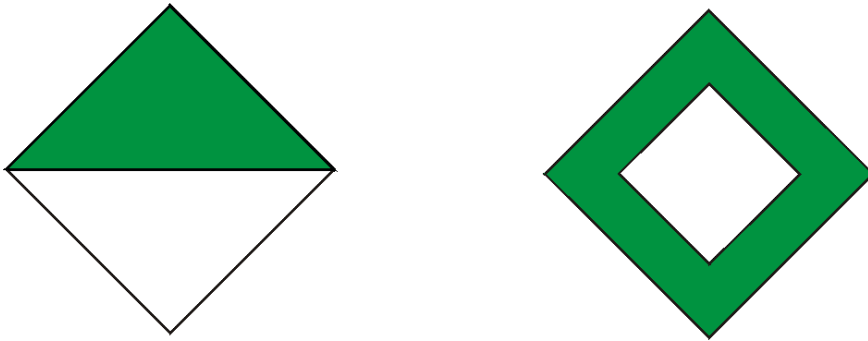

(fig. 6)

Colour: green/white

Form: post with topmark

Topmarks: square board (diagonals horizontal and vertical), upper half painted green and lower half white; or square frame (diagonals horizontal and vertical), painted green

Light (when fitted): rhythmic green light.

3. Use of marks

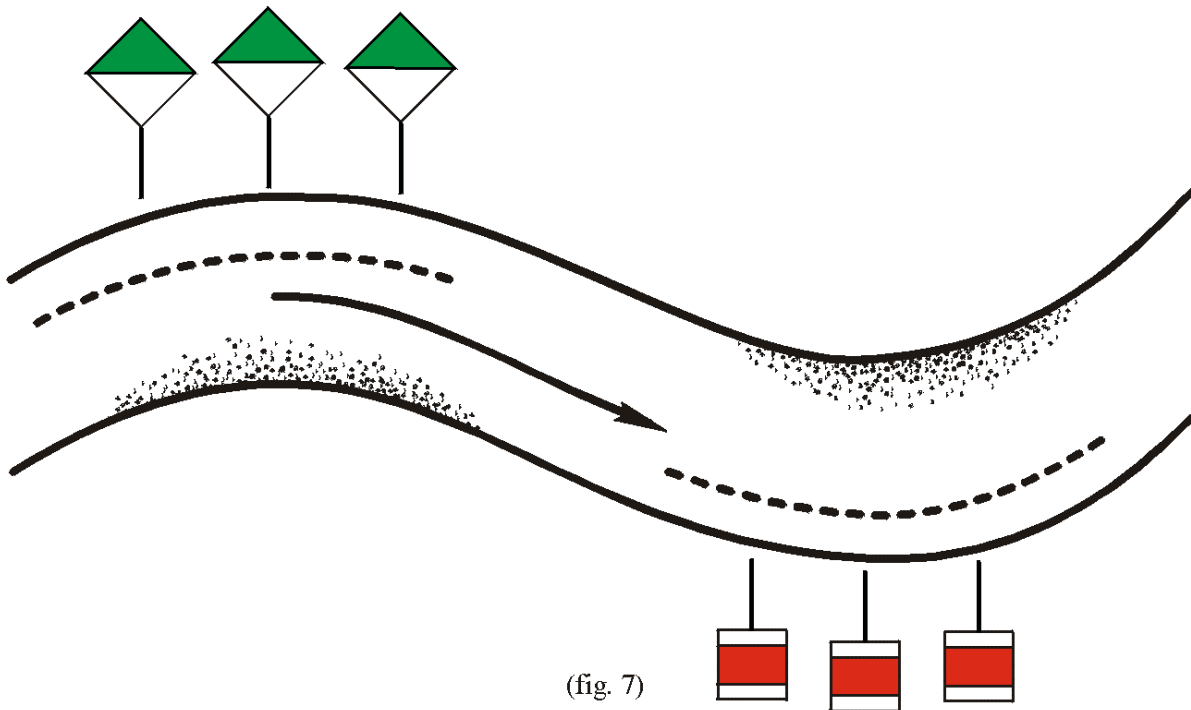

(fig. 7)

B. *Marking of cross-overs*

These marks indicate at what point the channel passes from one bank to another and also give the axis of this cross-over.

1. Right bank



(fig. 8)

Colour: yellow/black

Form: post with topmark

Topmark: square yellow board (sides horizontal and vertical), with a central vertical black stripe;
or a lath-assembled St. George's Cross painted yellow

Light (when fitted): yellow light, flashing or occulting, with an even-number characteristic other than the group-flashing rhythm with a group of two flashes.

2. Left bank

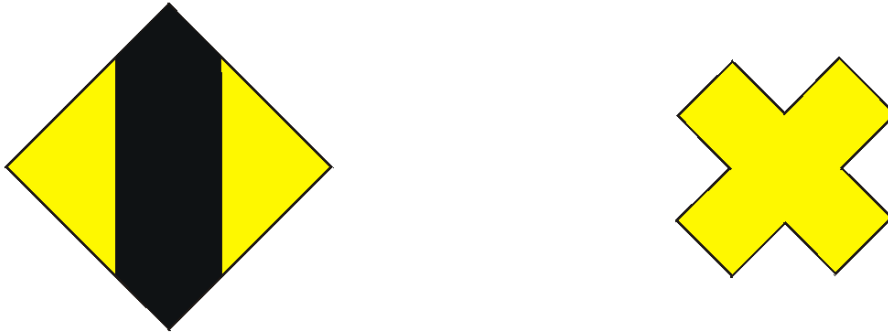

(fig. 9)

Colour: yellow/black

Form: post with topmark

Topmark: square yellow board (diagonals horizontal and vertical), with a central vertical black stripe; or a lath-assembled St. Andrew's Cross painted yellow

Light (when fitted): yellow light, flashing or occulting, with an odd-number characteristic other than the group-flashing rhythm with a group of three flashes.

3. Use of marks

3.1 Mere indication of cross-over

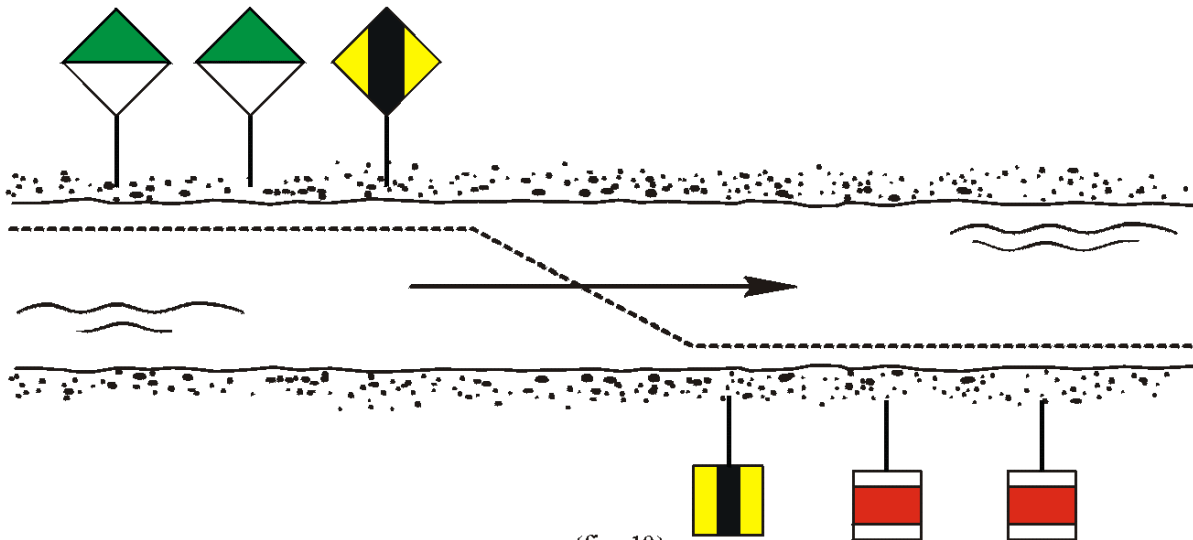

(fig. 10)

3.2 Indication of the axis of a long cross-over

Two identical signs placed one behind the other on the same bank, forming an alignment marking the axis of a long cross-over.

Lights (if any): yellow (the forward light and rearward light generally having the same rhythm; however, the rearward light may be a fixed light).

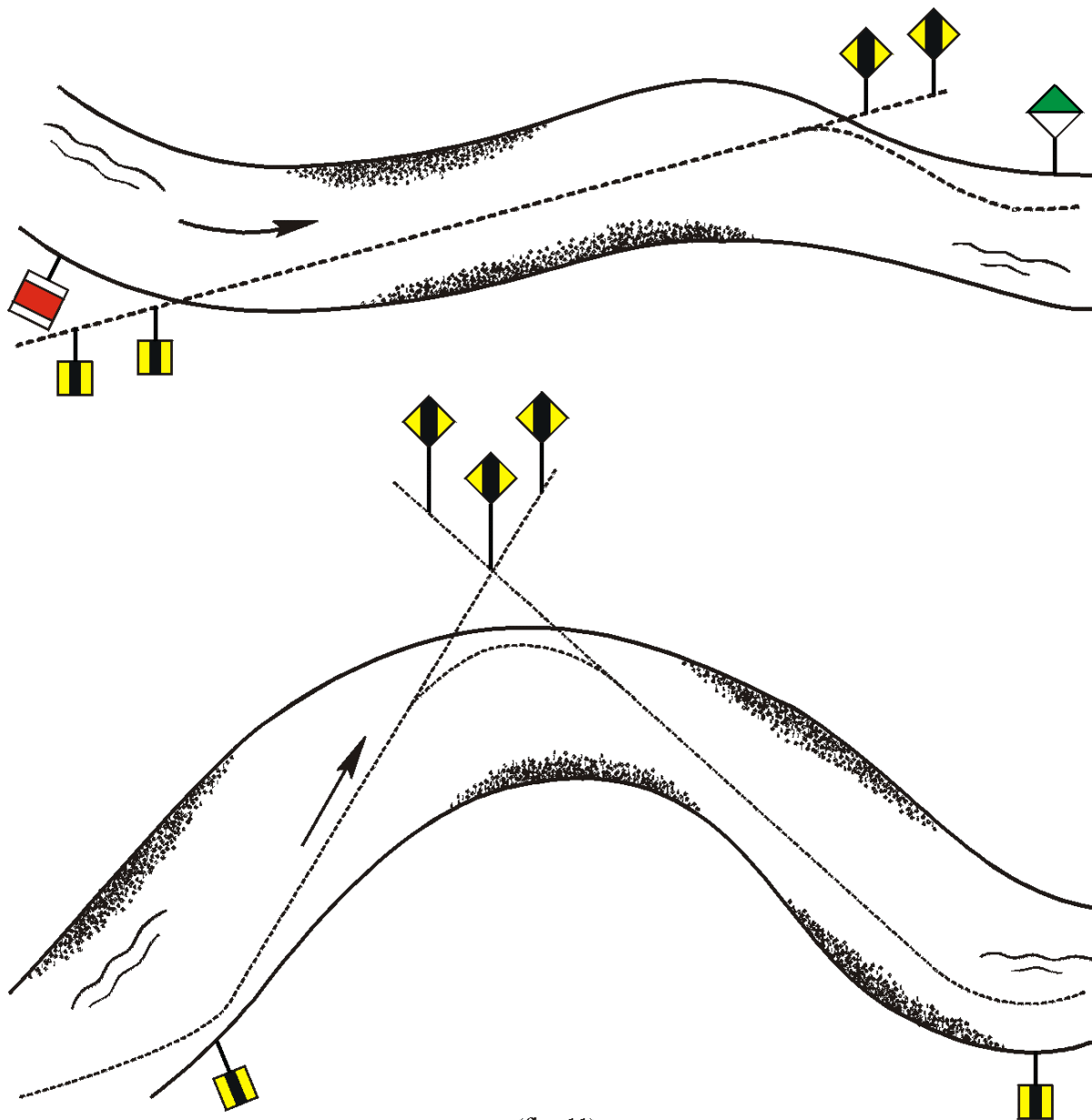

(fig. 11)

IV. BUOYAGE AND MARKING OF DANGER POINTS AND OBSTACLES

A. *Fixed marks*

1. Right-hand side

Colour: red

Form: post with topmark

Topmark: red cone, point downwards

Light (when fitted): rhythmic red light.

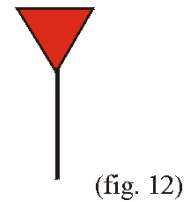

2. Left-hand side

Colour: green

Form: post with topmark

Topmark: green cone, point upwards

Light (when fitted): rhythmic green light.

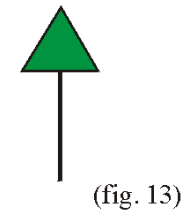

3. Bifurcation

Colour: red/green

Form: post with topmark

Topmark: red cone, point downwards, above a green cone, point upwards

Light (when fitted): continuous scintillating white light
or isophase white light
(may be the group-flashing white light
with a group of three flashes)

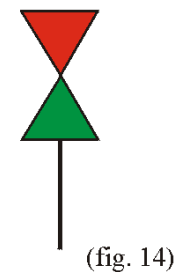

The above cones may be replaced by triangular panels with a white background and a red or green border.

4. Secondary arms of the waterway, mouths of waterways and entrances to harbours

On the approach to secondary arms of the waterway, to mouths of waterways and to harbour entrances, the bank walls on both sides of the waterway may be marked as far as the head of the dividing mole by the fixed marks described in 1 and 2 above, figures 12 and 13. Vessels entering the harbour are regarded as upstream traffic.

B. *Buoys*

1. Right-hand side

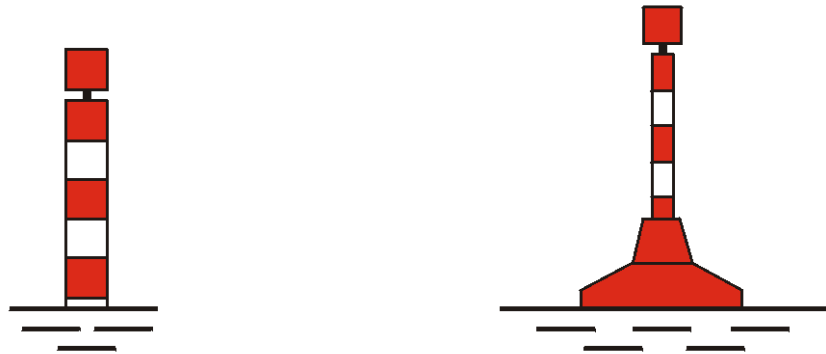

(fig. 15)

Colour: horizontal red and white bands

Form: spar-buoy or spar

Topmark: red cylinder

Light (when fitted): rhythmic red light
Generally with radar reflector.

2. Left-hand side



(fig. 16)

Colour: horizontal green and white bands

Form: spar-buoy or spar

Topmark: green cone, point upwards

Light (when fitted): rhythmic green light
Generally with radar reflector.

Example of use of the buoyage and marking described in chapters II and IV

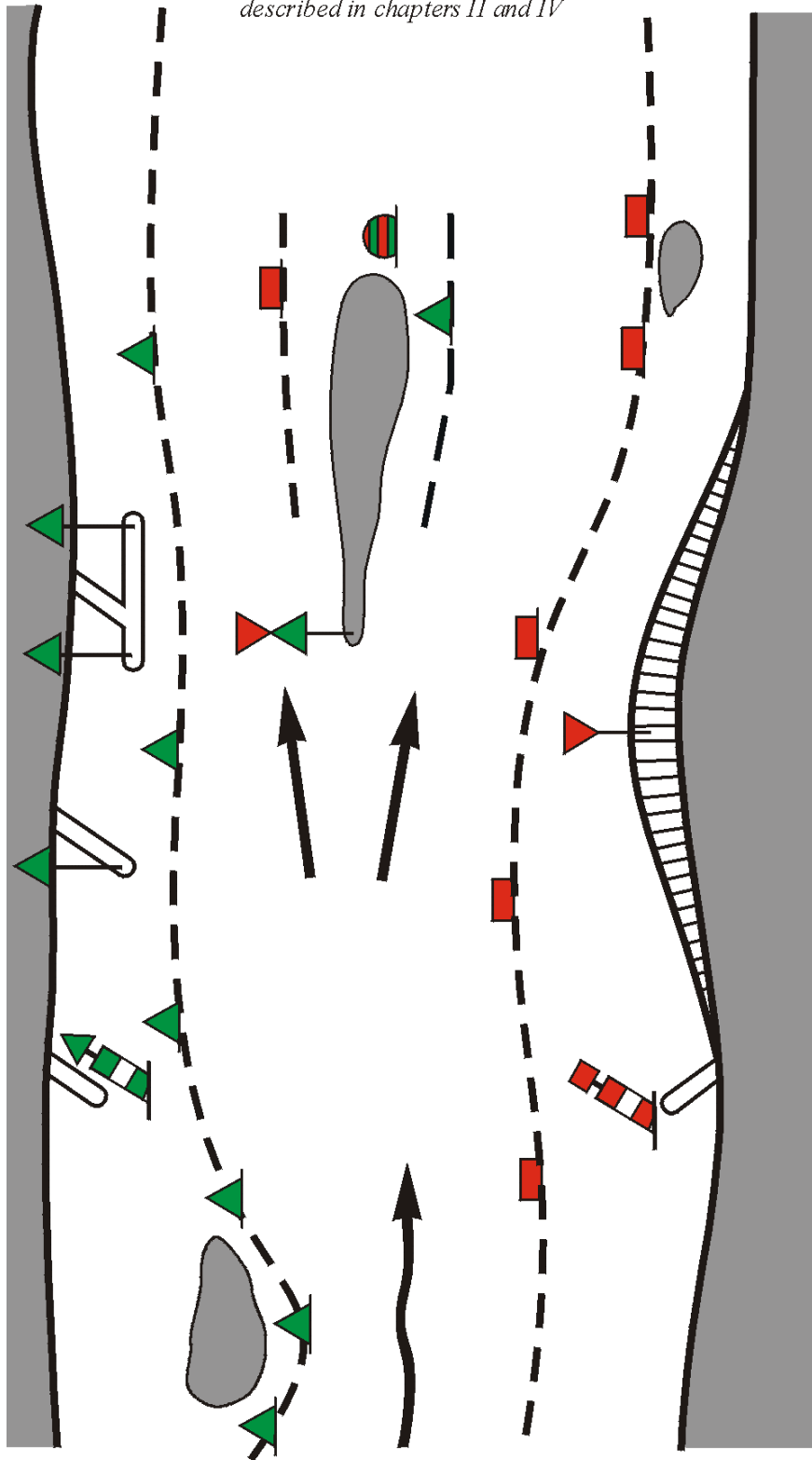

(fig. 17)

V. ADDITIONAL MARKING FOR NAVIGATION BY RADAR

A. Marking of bridge piers (if necessary)

1. Yellow floats with radar reflector (placed upstream and downstream from piers)

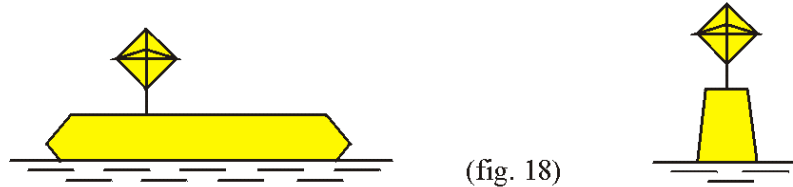

2. Pole with radar reflector placed upstream and downstream from bridge piers

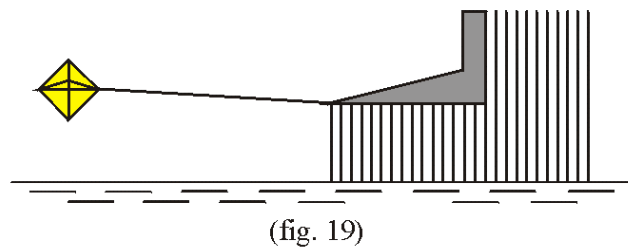

B. Marking of overhead cables (if necessary)

1. Radar reflectors secured to the overhead cable (giving a radar image of a series of points to identify the overhead cable)

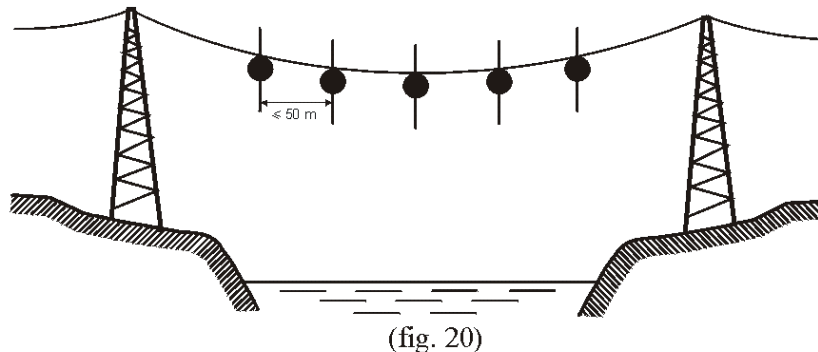

2. Radar reflectors placed on yellow floats arranged in pairs near each bank (each pair giving a radar image of two points side by side to identify the overhead cable)

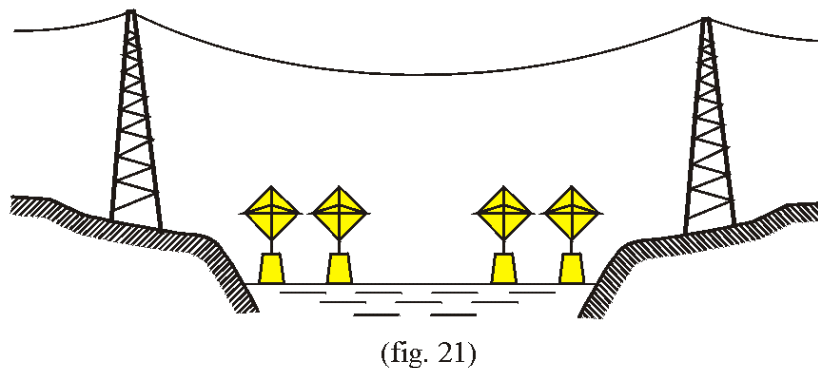

VI. **ADDITIONAL BUOYAGE AND MARKING OF LAKES AND BROAD WATERWAYS**

A. *Marking of danger points, obstacles and special features*

1. Cardinal marks

Definition of cardinal quadrants and marks

The four quadrants (North, East, South and West) are bounded by the true bearings NW-NE, NE-SE, SE-SW, SW-NW taken from the point of interest.

A cardinal mark is named after the quadrant in which it is placed.

The name of a cardinal mark indicates that the mark should be passed on the side of the quadrant named.

Description of cardinal marks

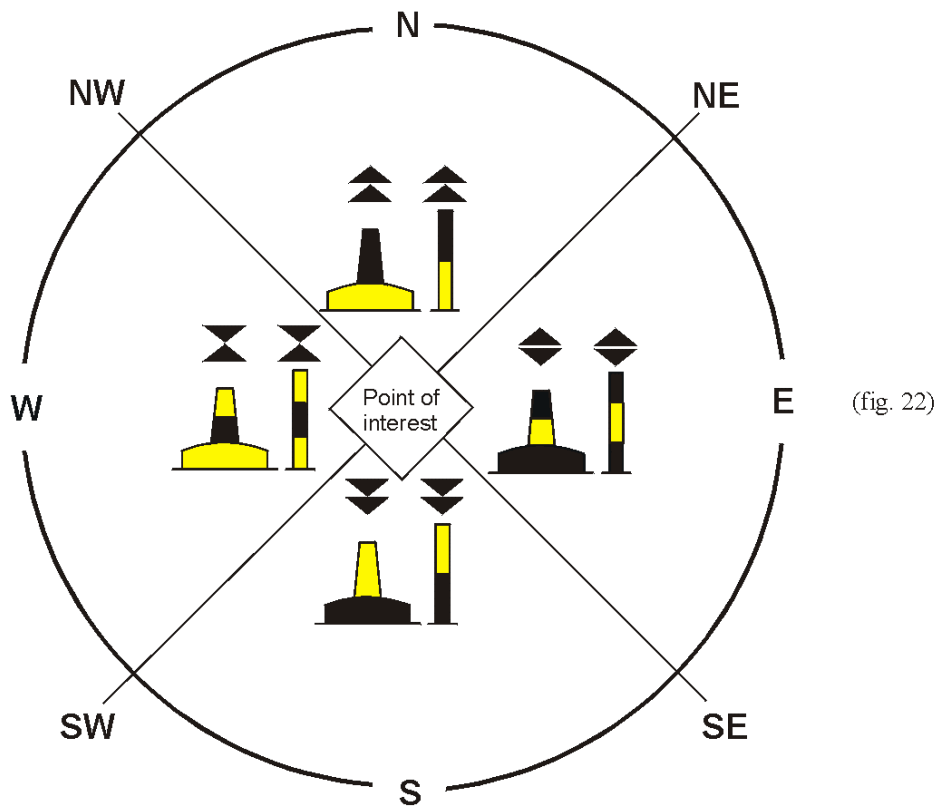

(fig. 22)

North cardinal mark

- Colour : black above yellow
- Form : pillar or spar, with topmark
- Topmark : two black cones, one above the other, points upward
- Light (when fitted):
 - Colour : white
 - Rhythm : continuous quick scintillating or continuous scintillating

East cardinal mark

- Colour : black with a single broad horizontal yellow band
- Form : pillar or spar, with topmark
- Topmark : two black cones, one above the other, base to base
- Light (when fitted):
 - Colour : white
 - Rhythm : group quick scintillating or group scintillating, with a group of three flashes

South cardinal mark

- Colour : yellow above black
- Form : pillar or spar, with topmark
- Topmark : two black cones, one above the other, points downward
- Light (when fitted):
 - Colour : white
 - Rhythm : group quick scintillating or group scintillating, with a group of six flashes followed by a long flash of not less than two seconds duration

West cardinal mark

- Colour : yellow with a single broad horizontal black band
- Form : pillar or spar, with topmark
- Topmark : two black cones, one above the other, point to point
- Light (when fitted):
 - Colour : white
 - Rhythm : group quick scintillating or group scintillating, with a group of nine flashes

2. Isolated danger marks

An isolated danger mark is a mark erected on, or moored above an isolated danger which has safe water all around it.

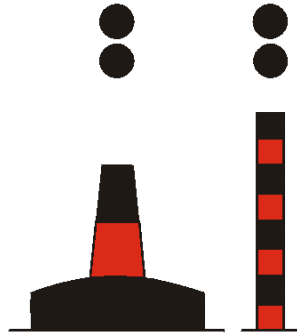

(fig. 23)

Colour : black with one or more broad horizontal
 Form : any (generally pillar or spar) with topmark
 Topmark : two black spheres, one above the other
 Light (when fitted):
 Colour : white
 Rhythm : group flashing (group of two flashes)

B. *Marking of the axis of a channel, the middle of a channel or a landfall*

Safe-water marks

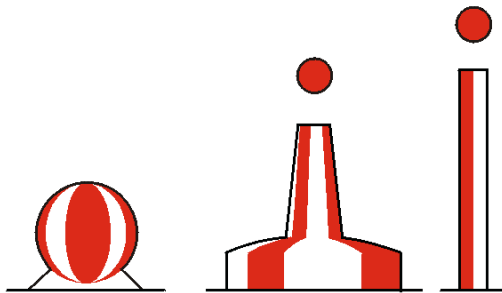

(fig. 24)

Colour : red and white vertical stripes
 Form : spherical buoy or pillar or spar with topmark
 Topmark
 (if any) : single red sphere
 Light (when fitted):
 Colour : white
 Rhythm : isophase, single-occluding, one long flash every 10 seconds or Morse code "A"

C. *Weather signs and signals on lakes*

“Caution” warning

A yellow light producing about 40 flashes per minute constitutes a “caution” warning.

The “caution” warning indicates the probable onset of a dangerous phenomenon without specifying the time thereof.

“Danger” warning

A yellow light producing about 90 flashes per minute constitutes a “danger” warning.

The danger warning indicates the imminent arrival of a dangerous phenomenon.

VII. MARKING OF PROHIBITED OR RESTRICTED AREAS

1. Special marks

Colour:	yellow
Form:	any, but different from navigational marks
Topmark (if any):	single yellow “X” shape
Light (when fitted):	
Colour:	yellow
Rhythm:	any, other than those described in chapter VI.

2. The nature of the prohibition or restriction shall, insofar as possible, be made clear in writing (for instance, in charts) and by local information.

Local information may be carried on yellow buoys. It may also be given by means of topmarks placed on such buoys in lieu of a topmark as prescribed above. For example, buoys at the edge of a zone where navigation is totally prohibited may carry a staff with a rigid, triangular red pennon.

Information may be given on boards placed on the bank and representing any of the prohibitory or informative signs prescribed in annex 7, sections I.A and I.E. Such boards may, if necessary, be supplemented by an arrow indicating the direction of the area to which the sign applies (see annex 7, section II.3).

3. If a shore zone in which one or more types of vessel or activity are prohibited or restricted is crossed by a channel in which one such type of vessel or activity is not prohibited or restricted (except as regards an entrance to a harbour to which section II applies), the sides of that channel may, again, be marked by yellow buoys. The upper parts of the two buoys at the entrance may, if necessary, be painted red on the right-hand side and green on the left-hand side for a boatmaster leaving the channel.

On the bank, boards as prescribed in annex 7, E.15 to E.20, may indicate the type of craft or activity permitted (e.g. the “water skiing” permission sign to indicate a water-skiing channel across an area where all navigation, or only water skiing, is prohibited); the markings may be supplemented by the arrow prescribed in annex 7, section II.3.

Where a zone open for more than one activity is crossed by a channel in which only one activity is permitted, the sides of that channel may be marked as in the above case. A board on the bank may indicate the activity permitted.

VIII. BUOYS FOR MISCELLANEOUS PURPOSES

If buoys are required for purposes other than those referred to above, they shall be predominantly white. They may carry pictograms.

IX. ENTRANCES TO HARBOURS

1. Marking of the entrance

By day

To port of a vessel entering: red device, generally cylindrical; or a post with a cylindrical red topmark; or a red rectangle painted in the jetty;

To starboard of a vessel entering: green device, generally conical; or a post with a conical green topmark; or a green triangle, point upward, painted on the jetty.

At night

The day markings described above may be illuminated.

If lights are used:

To port of a vessel entering: a red light, generally rhythmic;

To starboard of a vessel entering: a green light, generally rhythmic.

In certain cases, only one of these lights may be used.

2. This marking may be also used for entrances to tributary waterways, entrances to secondary arms of waterways and entrances to docks.

The following sketch illustrates the provisions of chapters VI, VII and IX.

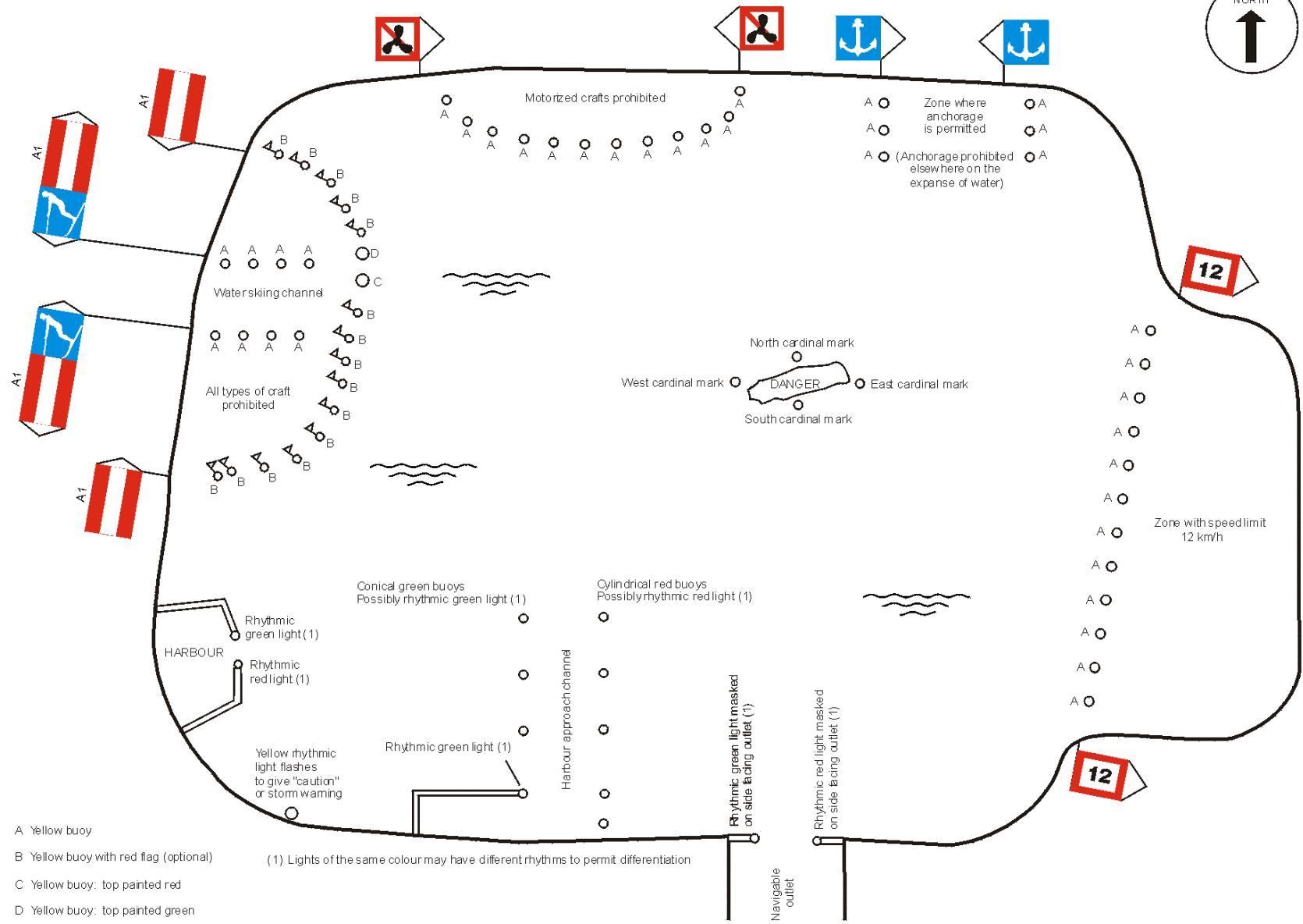

A ○ Zone where anchorage is permitted
 A ○ (Anchorage prohibited elsewhere on the expanse of water)

- A Yellow buoy
- B Yellow buoy with red flag (optional)
- C Yellow buoy: top painted red
- D Yellow buoy: top painted green

(1) Lights of the same colour may have different rhythms to permit differentiation

Annex 9

Model used-oil log

USED-OIL LOG

Page 1

Order No:

.....
Type of vessel Name of vessel

Official number
or tonnage measurement number:

Place of issue:

Date of issue:

This log containspages

Seal and signature of the authority issuing the log

.....

Making-out of used-oil logs

The first used-oil log, carrying order number 1 on page 1, is issued only by the authority which made out the vessel's certificate. This authority shall also enter the required particulars on page 1.

All the following logs, numbered by order, shall be made out by a competent local authority, but shall only be issued on presentation of the previous log. The previous log shall be indelibly stamped "Not valid" and returned to the boatmaster. It shall be kept on board for six months following the last entry.

Page 2 and following

Oily and greasy wastes accepted, occurring during the operation of the vessel:

Waste oil	l
<u>Bilge water from:</u>		
Aft engine room	l
Fore engine room	l
Other premises	l
<u>Other oily and greasy waste:</u>		
Used rags	kg
Waste grease	kg
Used filters	units
Receptacles	units

.....
.....

Other comments:

.....
.....

Place:

Date:

Seal and signature of the reception facility

Supplement

SPECIFIC REQUIREMENTS IN THE NATIONAL REGULATIONS OF BELARUS, KAZAKHSTAN, THE REPUBLIC OF MOLDOVA, THE RUSSIAN FEDERATION AND UKRAINE THAT DIFFER AT PRESENT FROM THE PROVISIONS OF CEVNI

Chapter 1

GENERAL PROVISIONS

Article 1.01 - Meaning of certain terms

(d) The term “small size craft” means any vessel with a hull less than 7 m long, including rowing boats of any length.¹

Chapter 3

VISUAL SIGNALS (MARKING) ON VESSELS²

Article 3.08 - Night marking for motorized vessels proceeding alone

1. Single motorized vessels shall carry:

(a) A masthead light; a vessel 50 m, but not more than 110 m, long may carry a second masthead light placed behind and above the forward light; a vessel 110 m or more long shall carry a second masthead light;

(b) Side lights;

(c) On vessels with a width of more than 5 m, three stern lights placed in a triangle with the base downwards or, on vessels with a width of not more than 5 m, one stern light placed on the centreline of the vessel.

2. Motorized displacement passenger vessels operating on ferry services or intra-urban lines within the limits of port waters and motorized ferries shall, when under way, carry in addition to the lights prescribed in paragraph 1 of the present article a yellow flashing light visible from all directions placed above the masthead light.

¹ The term “small size craft” should apply to a subcategory of “small craft”, as defined in CEVNI article 1.01 (d).

² CEVNI prescribes day markings for vessels under way. The national regulations in force in Belarus, Kazakhstan, Lithuania, Republic of Moldova, Russian Federation and Ukraine make no provision for such markings.

Article 3.10 - Night marking for pushed convoys

1. The pushing vessel shall carry:
 - Three masthead lights placed in the same plane in an equilateral triangle with the base downwards, the top light to be placed on the centreline of the vessel;
 - Side lights;
 - Three stern lights placed in the same plane in an equilateral triangle with the base downwards and above it a towing light, save that a vessel with a width of 5 m or less shall carry only a towing light.
2. Pushed vessels shall carry:
 - In the case of a single vessel, one masthead light at the bow;
 - In the case of a convoy, one masthead light at the bow of each leading vessel.

Article 3.14 - Additional night marking for vessels carrying out certain transport operations involving dangerous substances

1. Vessels carrying out the transport operations involving dangerous substances of classes 1 and 2 that are referred to in annex B.1, marginal 10 500, of the European Provisions concerning the International Carriage of Dangerous Goods by Inland Waterway (ADN) or vessels that have not been degassed following the transport of such substances shall carry, in addition to the lights prescribed in these regulations, two red masthead lights placed below the forward white light.
2. Vessels carrying out transport operations involving dangerous substances of classes 3, 4 (other than ore or coal), 5, 6 or 7 or vessels that have not been degassed following the transport of such substances shall carry, in addition to the lights prescribed elsewhere in these regulations, one red masthead light placed below the forward white light.
3. Towing vessels or pushers shall carry, in addition to the lights prescribed in these regulations:
 - (a) If the convoy contains vessels such as are referred to in paragraph 1, two red masthead lights placed above the white lights or the triangle;
 - (b) If the convoy contains vessels such as are referred to in paragraph 2, one red masthead light placed above the white lights or the triangle;
 - (c) If the convoy contains vessels such as are referred to in paragraph 1 and in paragraph 2 (mixed convoy), two red masthead lights placed above the white lights or the triangle.

Article 3.16 - Night marking for ferry-boats under way

1. Ferry-boats not moving independently shall carry:
 - (a) A white light visible from all directions, placed at a height of not less than 5 m; this height may, however, be reduced to 3 m if the ferry-boat is not more than 15 m long;
 - (b) A yellow light visible from all directions, placed about 1 m above the light referred to in (a) above;
 - (c) The leading boat or float of a longitudinal-cable ferry-boat shall carry a white light visible from all directions, placed not less than 3 m above the water level.

The ferry cable shall be illuminated near each bank by lights covered at the top by protective visors.

2. A motorized vessel engaged in ferry traffic by pushing, or by towing on a cable or alongside a non-self-propelled vessel (ferry) shall carry, in addition to the prescribed lights, a flashing yellow light visible from all directions.

The non-self-propelled vessel shall carry: if being pushed, one white masthead light; if being towed and less than 50 m long, one white light visible from all directions; if being towed and more than 50 m long, two lights visible from all directions, placed at the bow and stern.

Chapter 5

WATERWAY SIGNS AND MARKING

Article 5.01 - Signs

Annex 7 to the Inland Waterway Navigation Rules of Belarus, Kazakhstan, the Republic of Moldova, the Russian Federation and Ukraine defines the prohibitory, mandatory and informative signs and gives their meanings.

Article 5.02 - Waterway marking

Waterway Navigation Rules of Belarus, Kazakhstan, the Republic of Moldova, the Russian Federation and Ukraine defines the marking and lights which may be used in the channel on waterways and to regulate the movement of

Chapter 6

RULES OF THE ROAD

Article 6.02 - Small size craft

1. Small size craft shall remain outside the limits of the channel or of the prescribed traffic lanes. Where waterway conditions make this impossible, they may proceed along the channel within 10 m of its right-hand edge; in doing so, they shall not hamper other vessels' movement or manoeuvring in the channel and shall let them pass in good time without the exchange of sound or visual signals. Small size craft may not require other vessels to give way to them.
2. When two small size craft are crossing in such a manner that there is a risk of collision, the following rules shall apply:
 - Motorized small size craft shall give way to all other small size craft;
 - Small size craft that are neither motorized nor under sail shall give way to small size craft under sail.
3. When two craft under sail are crossing in such a manner that there is a risk of collision, one of them shall give way to the other as follows:
 - (a) When each craft has the wind on a different side, the craft with the wind on the port side shall give way to the other;
 - (b) When both craft have the wind on the same side, the craft which is to windward shall give way to the craft to leeward;
 - (c) If a craft which has the wind on the port side sees another craft to windward and cannot determine with certainty whether the other craft has the wind on the port or on the starboard side, it shall give way to that other craft. However, a craft which is on the starboard side of the channel shall maintain its course.
4. Small size craft and craft under sail may, if necessary, cross the channel (traffic lane, recommended course) or make turns involving crossing of the channel, generally astern of passing vessels. Any such manoeuvre ahead of an approaching vessel shall be made not less than 1 km from it.

The crossing shall be effected at an angle of close to 90 degrees and in as short a time as possible.

5. Small size craft and craft under sail may not, except when they are performing work-related tasks:

(a) Manoeuvre or stop in the vicinity of, or in the spaces between other vessels, dredgers, floating cranes, etc. that are under way or stationary;

(b) Stop or anchor within the limits of the channel (traffic lane, recommended course) or near floating navigation signs;

(c) Enter the channel in visibility of less than 1 km. Craft under sail may not enter the channel at night either.

Article 6.04 - Meeting: Normal rules

1. Vessels on sections with two-way traffic shall proceed along the right-hand side of the traffic lane or, where that is difficult (because of waterway, hydrometeorological or other conditions), shall keep to the centreline of the channel, remaining ready to pass safely to port of oncoming vessels. To this end, each vessel shall, insofar as that is necessary and safe, veer in good time to starboard and shall continue in that manner until the oncoming vessel has been left astern.

2. The vessel proceeding upstream shall first, and in good time or, in the event that its field of view is restricted by waterway conditions, on sighting an oncoming vessel coordinate its actions by radiotelephone and give a visual signal from its port side.

The vessel proceeding downstream shall accept the side designated for passing and confirm it without delay by giving a visual signal.

3. In the event that, because of waterway conditions or any other reasons, passing is difficult, a vessel proceeding upstream shall, as soon as it detects a vessel proceeding downstream, regulate its own movement in such a manner that the meeting occurs at the most convenient place. To this end, it shall, insofar as that is necessary and safe, veer in good time to starboard and shall pass the oncoming vessel to port.

4. When two vessels are meeting in such a manner that there is a risk of collision, each vessel shall alter its course to starboard so as to pass to port of the other.

5. When passing, vessels which do not have properly functioning radiotelephone sets and vessels which have been unable to communicate with each other by radiotelephone shall exchange sound signals.

Article 6.05 - Meeting: Departures from normal rules

1. In the event that passing an oncoming vessel to port is impossible, the vessel proceeding upstream shall move in good time to the most convenient place on the left-hand side of the channel, veer to port insofar as that is necessary and safe and pass the oncoming vessel to starboard. To this end, it shall coordinate its actions in advance by radiotelephone and by visual signals from its starboard side.

Article 6.22 bis - Navigation when passing floating equipment at work or grounded or sunken vessels or vessels with a limited ability to manoeuvre

1. A vessel approaching a dredger at work in the channel or a grounded vessel shall, at a distance of not less than 1 km, give the sound signal “Caution” (one long blast) and agree on the passing side by VHF radio.
2. A dredger engaged in deepening the channel shall free enough of the channel for the vessel to pass and shall indicate the passing side: at night, by two scintillating awning lights (green if the dredger has moved to the left-hand side and red if it has moved to the right); in the daytime, by a rhythmic light signal or a flag signal.
3. A dredger engaged in clearing the channel shall indicate the passing side: at night, by one scintillating light visible from all directions (white if it is working on the left-hand side of the channel and red if it is working on the right); in the daytime, by a rhythmic light signal or a flag signal.
4. On receiving the permission signal, the vessel shall give a visual signal from the side concerned and proceed, taking the requisite precautions.
5. The exchange of signals with, and the passing of a vessel engaged in underwater or diving operations in the channel (raising of wrecks, laying of pipes or cables, etc.) or a grounded vessel shall be effected in the same way as for dredgers engaged in clearing the channel.
6. When vessels are simultaneously approaching a dredger from upstream and from downstream, the vessel proceeding downstream or, irrespective of its direction, the high-speed vessel shall pass first.
7. When passing is impossible, dredgers and grounded vessels shall give the “Warning” signal (series of short blasts) in good time, but not less than 1 km from the approaching vessel.

A vessel which has received the “Warning” signal shall immediately stop until it receives permission to proceed without further inquiry.

8. A dredger shall not allow hopper barges servicing it to approach or move away while vessels are passing it.

E. PASSAGE UNDER BRIDGES AND THROUGH WEIRS AND LOCKS

Articles 6.24 to 6.26 - Passage under bridges

1. Passage under bridges shall be permitted only through bays intended for that purpose and equipped with navigation signs and lights approved under State standards in force.

The centreline of the navigable bays of fixed bridges shall be indicated by:

- For the passage of vessels proceeding upstream: square boards;

- For the passage of vessels proceeding downstream: diamond-shaped boards;
- For the passage of convoys of rafts: round boards; for the passage of small size craft: triangular boards.

The colour of the boards shall be red or white, depending on whether the background formed by the bridge structure is light or dark.

The lights on the boards shall be continuous:

- For vessels coming from downstream or upstream: two red lights placed in the vertical;
- For convoys of rafts: two green lights placed in the vertical.

To indicate the overhead clearance and the sides of the channel in bridge bays, 1, 2, 3 or 4 green or white square boards shall be installed on each bridge pier or at each side of the channel. The number of boards will show the height of the bay measured from the water level to be up to 10, 13, 16 m or more respectively.

All lights shall be green and fixed.

2. To indicate the navigable bay of a movable floating bridge, three lights shall be installed: two on the mobile part of the bridge and one at the end of the non-moving part.

The lights shall be fixed: red lights on the right-hand bank and green lights on the left-hand bank.

3. The passage of vessels through movable or floating bridges shall be regulated by the bridge owners with the help of traffic-light signals, in accordance with the following conventions:

- One or more red lights shall mean “Passage prohibited”;
- One or more green lights shall mean “Passage permitted”.

4. When approaching floating bridges, vessels shall, at a distance of not less than 1 km, give the “Caution” signal.

When passing under movable or floating bridges, vessels shall comply with the instructions of the body authorized to regulate navigation.

5. When vessels are simultaneously approaching a bridge having a single navigable bay from upstream and from downstream, the vessel proceeding downstream or, irrespective of its direction, the high-speed vessel shall pass under the bridge first.

6. When visibility is less than 1 km, vessels and pushed convoys shall only be permitted to pass under bridges if the navigable bays are fitted with navigation aids that enable the bays to be recognized reliably at a distance of not less than 0.5 km and vessels to orient themselves with confidence (visually or with the aid of instruments) on the approach to them. In addition, the width of the navigable bays shall be:

(a) For single vessels and single-file convoys: not less than five times the width of the vessel (convoy);

(b) For other pushed convoys: not less than three times the width of the convoy.

Article 6.27 - Passage through weirs

1. Passage through an opening in a weir shall be permitted if the opening is marked to the right and to the left by signs:

(a) To the right: two red lights at the upper and lower corners of the opening;

(b) To the left: two white lights at the same points.

2. Prohibition of passage through an opening in a weir shall be indicated by one or more red lights or (in the daytime) red-white-red boards.

Article 6.28 - Passage through locks

1. Vessels proceeding towards locking must notify the lock controller by radiotelephone not less than 1.5 hours beforehand (or, where this is impossible, as soon as reliable communication can be established) of the estimated time of approach to the limits of the lock.

2. The boatmaster shall, on approaching the limits of the lock, but at a distance of not less than 1 km, request from the lock controller by radiotelephone detailed information concerning the order of locking and give notice of his readiness for locking.

3. Passenger hydrofoils and hovercraft shall, in the event of joint locking, enter the lock chamber last and be positioned in such a manner that the only displacement vessels on their beam are small size craft.

4. Vessels carrying explosive or toxic substances shall enter locks in accordance with the locking schedule without stopping at tie-up walls.

5. On vessels heading for locking, the crew shall check the steering and the propelling-machinery remote-control system for reliability of operation, as well as the presence of the requisite air pressure in the starting-air bottles for the main engines.

6. Vessels (convoys) shall enter locks at a safe speed so as to avoid damaging the gates or protective devices or other vessels present in the lock and so that they can be stopped at their designated mooring places. To this end, it is recommended that, on displacement vessels having two or more main engines, one of the engines should be put into reverse in good time.

7. Vessels having a length of more than 75 m should be moored by not less than two mooring lines on one side.

For mooring to lock-chamber bollards, the lock staff shall apportion the requisite number of mooring hands. Mooring to floating mooring rings shall be effected by the crew of the vessel.

8. Joint locking of vessels shall be permitted as follows:
- Tankers and petroleum-product convoys carrying cargoes (or residues thereof) of any class in any combination;
 - Dry-cargo vessels/convoys (other than vessels carrying toxic or explosive or other flammable cargoes) and dredgers and marker vessels with tankers carrying petroleum products (or residues thereof) having a vapour flashpoint of 60° C or higher;
 - Passenger vessels (including high-speed vessels) with dry-cargo vessels/convoys (other than vessels carrying toxic or explosive or inflammable cargoes) or dredgers and marker vessels, as well as with tankers carrying fuel oil (or residues thereof) that is at a temperature of no more than 45° C and has a vapour flashpoint of 60° C or higher.
9. In the event of joint locking, the following rules shall apply:
- (a) Tankers shall, as a rule, enter the lock and take up position first; mooring of passenger vessels abeam of tankers shall be prohibited and the gap between a tanker and a passenger vessel shall be not less than 10 m;
 - (b) Dry-cargo vessels may be placed in a lock chamber abeam of a tanker providing the gap between the sides of the vessels is not less than 1 m;
 - (c) Tankers and other vessels that are locked jointly shall take the special fire precautions provided for in such cases.
10. Compliance with the instructions of the lock controller (watch-leader) concerning the positioning of vessels along tie-up walls, the order of locking and the positioning of vessels in the lock chamber shall be mandatory for the boatmasters of all vessels, who shall confirm receipt of those instructions by radiotelephone or, if the radiotelephone is out of order, by a sound signal.

If a boatmaster considers that an instruction he has received cannot be carried out, he must inform the lock controller accordingly and may not take any action until an agreed decision has been reached.

Article 6.28 bis - Entering and leaving locks

1. Vessels may only enter a lock chamber, move from one chamber to another or leave a chamber when the entry (exit) traffic light shows a green signal.

In the event of two-way locking, the vessels may only begin to move into the lock when the intermediate traffic light shows a green signal.

2. The absence of a signal from a traffic light is a prohibitory signal (equivalent to a red light). In such a case, a vessel may only continue moving with the permission of the lock controller as recorded in writing in the vessel's log and the lock records.

F. REDUCED VISIBILITY - NAVIGATION BY RADAR

Article 6.30 - General rules for navigation in visibility of less than 1 km

1. The rules of the present article shall apply to all vessels and convoys, with the exception of small size craft and craft under sail, during navigation in visual visibility of less than 1 km on inland waterways where the marking is to the sides and during navigation on waterway sections with navigation signs that are not illuminated at night.

2. Vessels shall be permitted to move in visibility of less than 1 km only if they have on board and use the following:

(a) A radar set and a device indicating their rate of turn that are in good working order;

(b) A radiotelephone providing vessel-to-vessel and vessel-to-shore communication that is in good working order;

(c) A device for emitting sound signals.

3. Movement on any inland waterway (other than waterways of zone "M")¹ in visibility of less than 1 km shall be prohibited for passenger vessels and vessels carrying petroleum products having a vapour flashpoint of less than 60° C or residues thereof or explosive or toxic substances or residues thereof.

4. Movement in visibility of less than 1 km shall be permitted for vessels other than those referred to in paragraph 3 of this article depending on the size of the channel, as follows:

(a) When the width of the channel is less than 100 m: movement by single vessels and pushed convoys having a single non-self-propelled vessel upstream only;

(b) When the width of the channel is 100 m or more, but less than 200 m: movement by single vessels in both directions, and movement by pushed convoys upstream only;

(c) When the width of the channel is 200 m or more: movement by vessels and convoys in both directions (in these conditions, movement by convoys of rafts shall only be permitted on lakes and reservoirs);

(d) On canals irrespective of the width of the channel: movement by single vessels and pushed convoys in both directions.

¹ Waterways of zone "M" are assimilated to maritime waterways.

5. In reduced visibility, passing and overtaking of vessels (convoys) shall be prohibited on sections where the channel has a width of less than 200 m if visual visibility is less than three vessel (convoy) lengths.

6. Vessels shall keep, in addition to a visual and a listening watch, a continuous radar watch by qualified crew.

When navigating by radar, there shall always be in the wheelhouse two boatmasters, one of whom shall be the captain or the captain's mate holding a captain's diploma, and a helmsman.

7. When conducting radiotelephone conversations, it must be clearly established, by giving of the position relative to discernible reference points, that the conversation is indeed being conducted with the vessel with which action must be coordinated.

8. Vessels under way or stationary in reduced visibility must give the following signals:

- Single vessels under way: one long blast;
- Convoys and rafts under way: one long and two short blasts at intervals of not more than one minute;
- Single vessels or convoys at anchor or aground within the limits of the channel: one short, one long and one short blast;
- A non-self-propelled vessel with a crew at anchor or aground within the limits of the channel: frequent peals of a bell or blows on a metal object.

Article 6.32 - Provisions for vessels navigating by radar

1. As soon as they see on the radar screen vessels (echoes) whose positions or movement may cause a dangerous situation, or when they are approaching a section where vessels not yet visible on the screen may be present, vessels navigating by radar shall:

(a) If single vessels, give one long blast, and if convoys, two long blasts. The signal shall be repeated as often as necessary;

(b) Give oncoming vessels, by radiotelephone, the information necessary for safe navigation;

(c) Reduce speed and, if necessary, stop.

2. A vessel which has only detected the presence of another vessel by radar must determine whether a situation of excessive proximity and danger of collision is developing. If that is the case, it shall take action in good time to pass. When that action is to change course, it shall, so far as that is possible, avoid:

(a) Changing course to port if the other vessel is forward of its beam and is not being overtaken;

(b) Changing course towards a vessel that is on or abaft its beam.

3. In visibility of less than 1 km, vessels and convoys proceeding in the same direction that do not intend to overtake one another shall maintain between themselves a safe distance, which shall not in any event be less than five times the vessel's braking distance at the speed in question.

4. In visibility of less than 1 km, vessels shall agree in good time by radiotelephone on the most convenient point for passing and shall only pass each other to port as follows:

(a) A vessel proceeding upstream shall, on approaching the agreed point, veer aside or reduce speed to a minimum and pass the oncoming vessel (convoy) to port;

(b) A vessel proceeding downstream shall, on approaching the agreed point, reduce speed in good time to a minimum, veer to starboard insofar as that is necessary and safe and continue in that manner until the oncoming vessel has been left astern;

(c) A vessel proceeding upstream shall pass a convoy of rafts on the side indicated by the vessel towing the convoy.

5. A vessel that is overtaking another in visibility of less than 1 km shall, by radiotelephone, obtain permission to overtake and reach agreement on the overtaking point and the precautions to be taken by each vessel.

Vessels and convoys shall only be overtaken on their port side; convoys of rafts shall be overtaken as indicated by the raft-convoy master.

Annex 4

COLOURS OF LIGHTS ON VESSELS

1. Lights on vessels may be green, white, yellow or red.

The colour characteristics of signal lights should correspond to the standards given below, which fall within the chromaticity limits established for each colour by the International Commission on Illumination (CIE): document CIE No. 2.2 (TC-1.6), of 1975: "Colours of light signals". The boundaries for each colour are defined by the coordinates given in table 1:

Table 1

Light colour	Coordinate	Intersecting points					
		1	2	3	4	5	6
Red	x	0.680	0.660	0.735	0.721	-	-
	y	0.320	0.320	0.265	0.259	-	-
Green	x	0.028	0.009	0.300	0.203	-	-
	y	0.385	0.723	0.511	0.356	-	-
White	x	0.525	0.525	0.452	0.310	0.310	0.443
	y	0.382	0.440	0.440	0.348	0.283	0.382
Yellow	x	0.612	0.618	0.575	0.575	-	-
	y	0.382	0.382	0.425	0.406	-	-

Annex 5

INTENSITY AND RANGE OF SIGNAL LIGHTS ON VESSELS

The intensity I in candela of a light for the visibility range stipulated in table 2 must be not less than that defined by the formula

$$I = 3.43 \times 10^6 TD^2 k^{-D}$$

where T = 2×10^{-7} lux, the light threshold;
D = the visibility range in nautical miles;
K = 0.8, the atmospheric transmission coefficient corresponding to a meteorological optical range of approximately 13 nautical miles.

Intensity values calculated in accordance with this formula are given in table 2.

The maximum permitted intensity may exceed the values shown in table 2 by up to 70% but must not be greater than 150 cd. This should not be attained by regulating the intensity of the light. The use of reflectors in signal and side lights is not permitted.

Table 2

Visibility range, D						
Nautical miles	1	2	3	4	5	6
Km	1.85	3.7	5.55	7.4	9.26	11.1
Light intensity, I (cd) where $k = 0.8$	0.9	4.3	12	27	52	9/1

Visibility ranges and angles of illumination are shown in table 3.

Table 3

No.	Type and colour of signal light	Visibility range (km)	Horizontal area illuminated	
			Angle of illumination (°)	Arc of visibility
1	Masthead light, white	8	225	In the centreline of the vessel, from the bow to 112.5° on either beam
2	Starboard side light, green	3.7	112.5	From directly ahead of the vessel to 22.5° abaft the starboard beam
3	Port side light, red	3.7	112.5	From directly ahead of the vessel to 22.5° abaft the port beam
4	Stern light, white	3.7	135	From directly astern the vessel to 67.5° on either beam
5	Towing light, yellow	3.7	135	Ditto
6	Circular light white	3.7	360	In all directions
	Circular light red	1.85		
	Circular light green	1.85		
	Circular light yellow	1.85		
7	Bi-coloured lantern, green and red	1.85	225	To 112.5° either side of the bow in the centreline: starboard - green sector port - red sector
8	Mooring and side light, white	3.7	180	90° forward and aft of the beam

No.	Type and colour of signal light	Visibility range (km)	Horizontal area illuminated	
			Angle of illumination (°)	Arc of visibility
9	Flashing light: daytime night-time	2	112.5+ +112.5	From the beam to the bow, overlapping in the centreline by 22.5°, and from the beam to the stern, overlapping in the centreline by 22.5°
		4		
10	Sweeping light	4	112.5+ +112.5	Ditto

Notes:

1. The visibility range of the white masthead lights carried by self-propelled vessels less than 20 m in length should not be less than 5.5 km; that of the red masthead lights, not less than 3.7 km.

2. The visibility range of the lights carried by self-propelled vessels less than 12 m in length should not be less than:

3.7 km masthead lights;
1.85 km side lights.

3. The visibility range of the lights carried by non-self-propelled vessels should not be less than:

4 km masthead lights on vessels 50 m and more in length;
2 km masthead lights on vessels less than 50 m in length;
1.85 km circular lights.

The use of lights meeting the requirements of the 1972 International Regulations for Preventing Collisions at Sea (COLREG) shall be permitted.
